

ISO SCALE 3 : 1

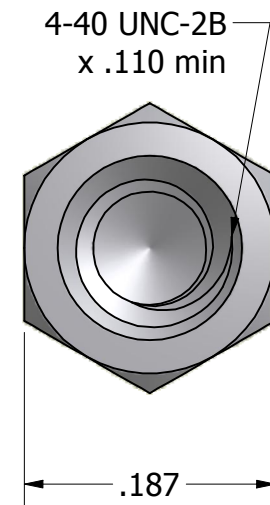
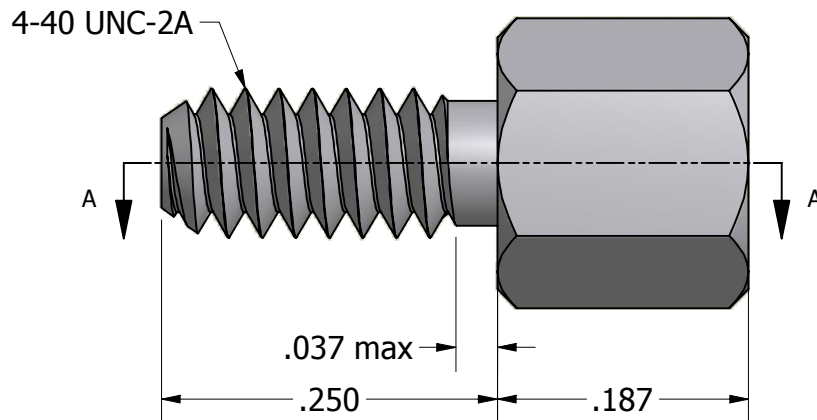

Tolerances Unless Otherwise Specified:

**.xx Decimal:** ± .01  
**.xxx Decimal:** ± .004  
**Fraction:** ± 1/64  
**Angle:** ± 2°

**LYN-TRON, INC.**

Part Number:

**ST9411**

Description:

**3/16 Hex Jack Screw**

Drawn By:

**kenang 10/13/2010**

Gauge:

Material:

**Steel 12L14**

Scale:

**7:1**