

SECTION A-A

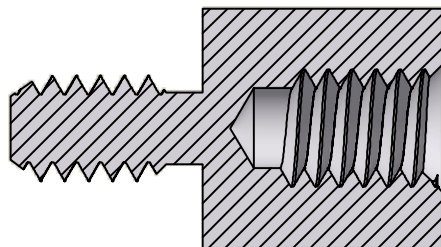

ISO SCALE 1 : 1

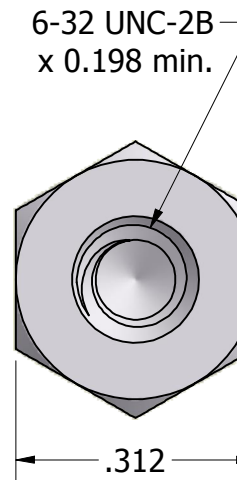
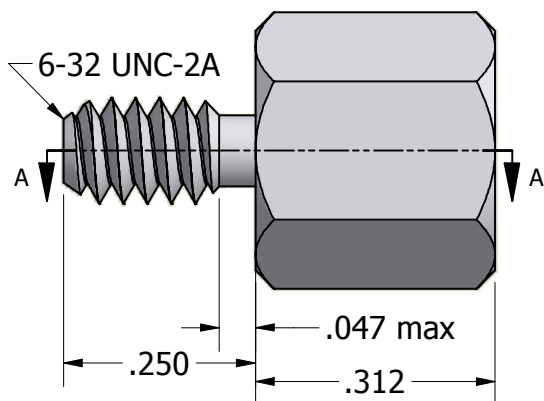

Tolerances Unless Otherwise Specified:

**.xx Decimal:** ± .02  
**.xxx Decimal:** ± .005  
**Fraction:** ± 1/64  
**Angle:** ± 2°

**LYN-TRON, INC.**

Part Number:

**ST6993-0.312**

Description:

**5/16 Hex Male-Female Standoff**

Drawn By:

**KENANG 07/06/2011**

Gauge:

Material:

**Steel**

Scale:

**4 : 1**