

SECTION A-A

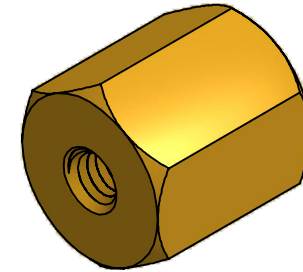

ISO SCALE 2 : 1

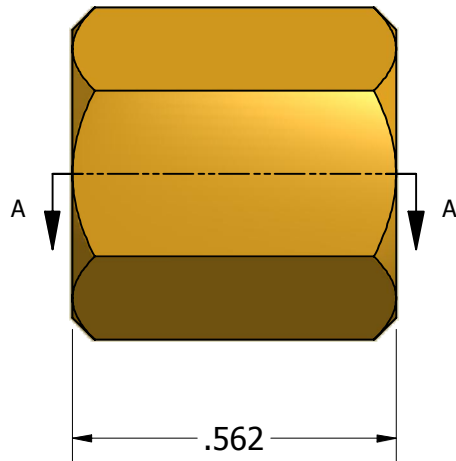

8-32 UNC-2B Thru

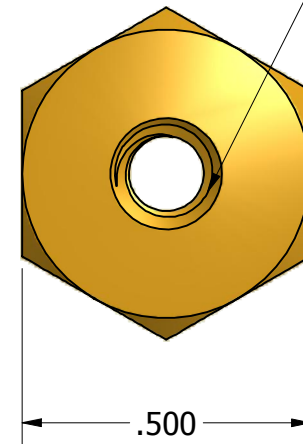

Tolerances Unless Otherwise Specified:

.xx Decimal: $\pm .02$
.xxx Decimal: $\pm .005$
Fraction: $\pm 1/64$
Angle: $\pm 2^\circ$

LYN-TRON, INC.

Part Number:

ST6955-0832-0.562

Description:

1/2 Hex Standoff

Drawn By:

JEFFN

07/10/2010

Gauge:

Material:

Steel

Scale:

3 : 1