

SECTION A-A

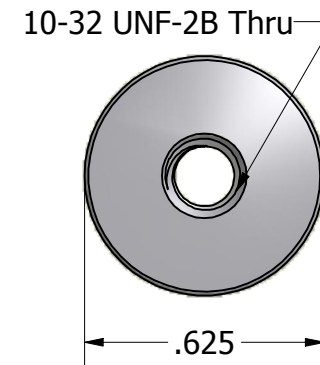

ISO SCALE 1 : 1

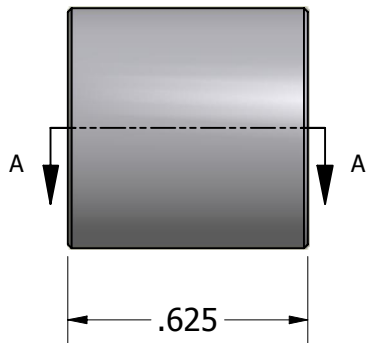

Tolerances Unless Otherwise Specified:			
.xx Decimal:	± .02		
.xxx Decimal:	± .005	Part Number:	
Fraction:	± 1/64	ST6946-1032-0.625	
Angle:	± 2°	Description:	
		5/8 Round Standoff	
Drawn By:	Gauge:	Material:	Scale:
JEFFN	07/12/2010	Steel	2 : 1