

SECTION A-A

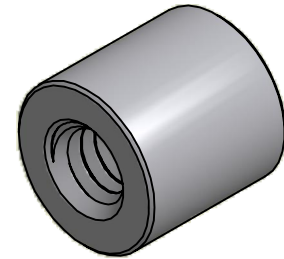

ISO SCALE 2 : 1

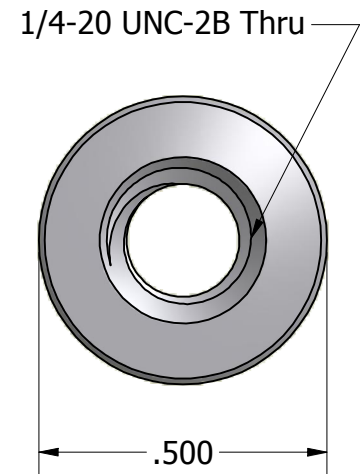
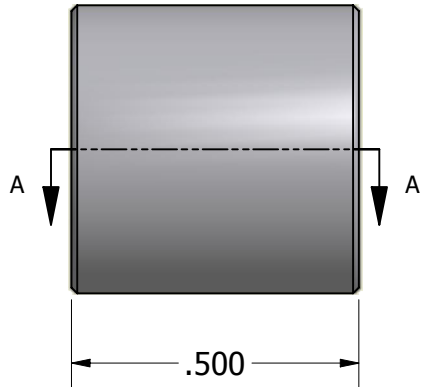

Tolerances Unless Otherwise Specified:

.xx Decimal: $\pm .02$
.xxx Decimal: $\pm .005$
Fraction: $\pm 1/64$
Angle: $\pm 2^\circ$

LYN-TRON, INC.

Part Number:
ST6945-2520-0.500

Description:
1/2 Round Standoff

Drawn By:
JEFFN 07/12/2010

Gauge:
Steel

Scale:
3 : 1