

SECTION A-A

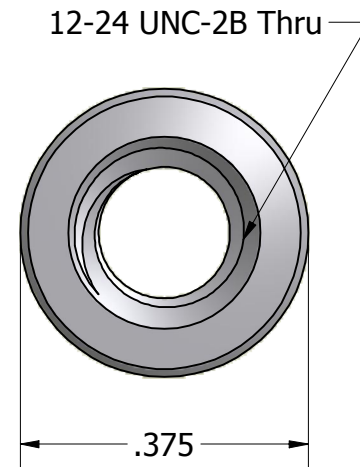

ISO SCALE 2 : 1

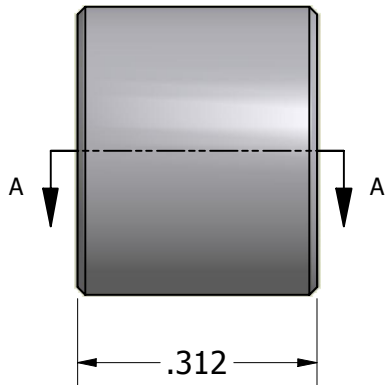

Tolerances Unless Otherwise Specified:

.xx Decimal: $\pm .02$
.xxx Decimal: $\pm .005$
Fraction: $\pm 1/64$
Angle: $\pm 2^\circ$

LYN-TRON, INC.

Part Number:

ST6943-1224-0.312

Description:

3/8 Round Standoff

Drawn By:

JEFFN

07/12/2010

Gauge:

Material:

Steel

Scale:

4 : 1