

SECTION A-A

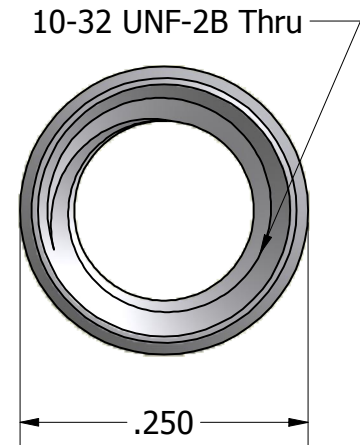

ISO SCALE 2 : 1

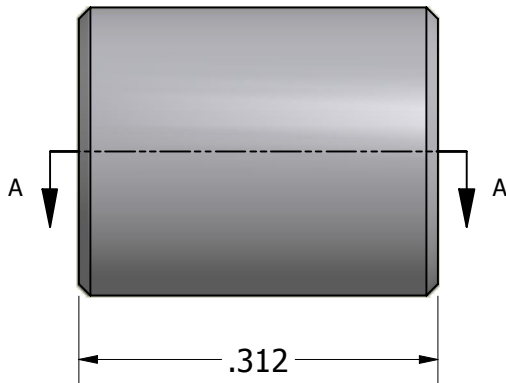

Tolerances Unless Otherwise Specified:

**.xx Decimal:**  $\pm .02$   
**.xxx Decimal:**  $\pm .005$   
**Fraction:**  $\pm 1/64$   
**Angle:**  $\pm 2^\circ$

**LYN-TRON, INC.**

Part Number:

**ST6941-1032-0.312**

Description:

**1/4 Round Standoff**

Drawn By:

**JEFFN**

**07/12/2010**

Gauge:

Material:

**Steel**

Scale:

**6 : 1**