

SECTION A-A

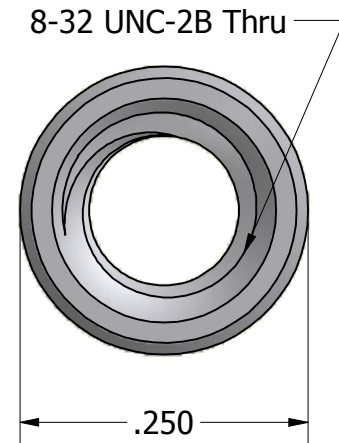

ISO SCALE 2 : 1

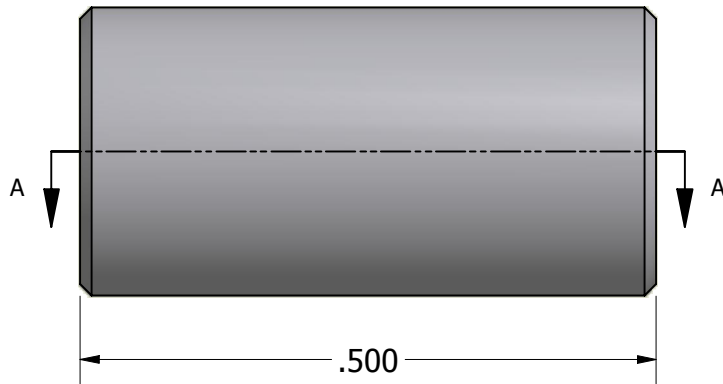

Tolerances Unless Otherwise Specified:

.xx Decimal: $\pm .02$
.xxx Decimal: $\pm .005$
Fraction: $\pm 1/64$
Angle: $\pm 2^\circ$

LYN-TRON, INC.

Part Number:
ST6941-0832-0.500

Description:
1/4 Round Standoff

Drawn By:
JEFFN 07/12/2010

Gauge:
Steel

Scale:
6 : 1