

SECTION A-A

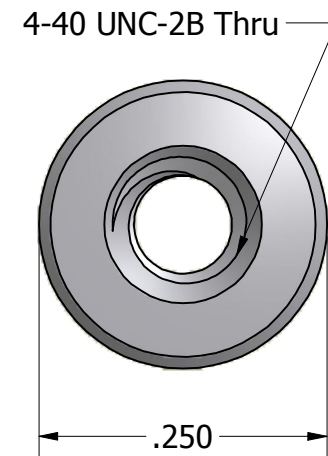

ISO SCALE 2 : 1

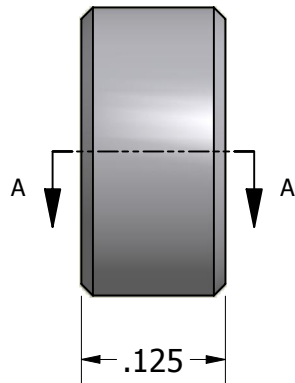

Tolerances Unless Otherwise Specified:

.xx Decimal: ± .02
.xxx Decimal: ± .005
Fraction: ± 1/64
Angle: ± 2°

LYN-TRON, INC.

Part Number:
ST6941-0440-0.125

Description:
1/4 Round Standoff

Drawn By:
JEFFN 07/12/2010

Gauge:
Steel

Scale:
6 : 1