

SECTION A-A

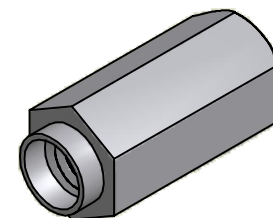

ISO SCALE 2 : 1

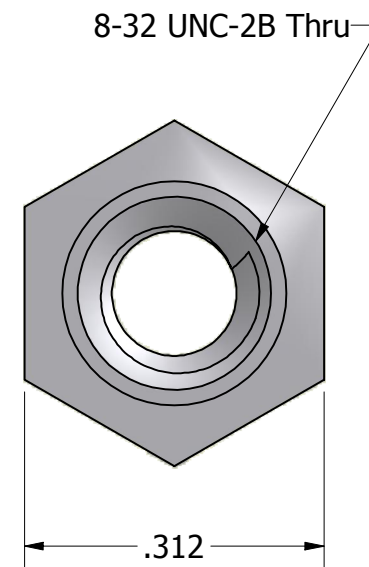
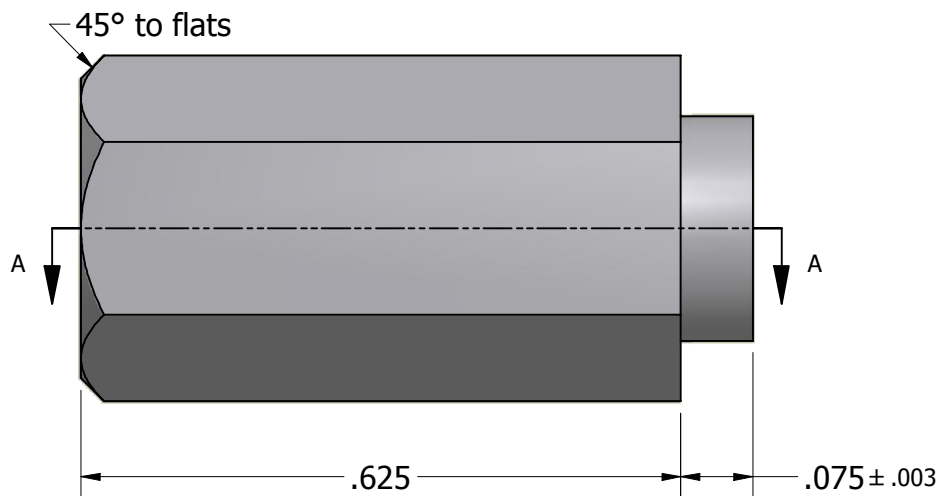

Tolerances Unless Otherwise Specified:

.xx Decimal: ± .02  
 .xxx Decimal: ± .005  
 Fraction: ± 1/64  
 Angle: ± 2°

**LYN-TRON, INC.**

Part Number:

**ST6923A-0.625**

Description:

**5/16 Hex Swage Standoff**

Drawn By:

**JEFFN**

**06/22/2010**

Gauge:

Material:

**Steel**

Scale:

**5 : 1**