

SECTION A-A

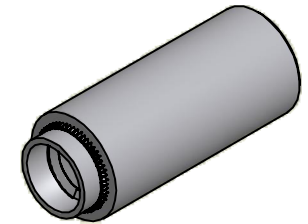

ISO SCALE 2 : 1

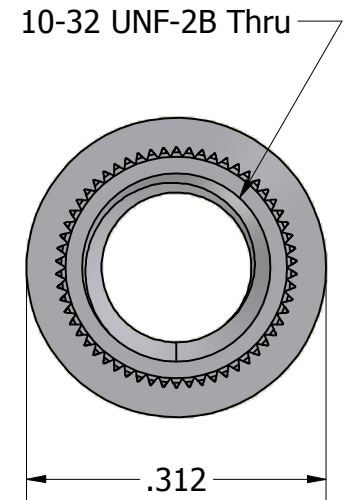
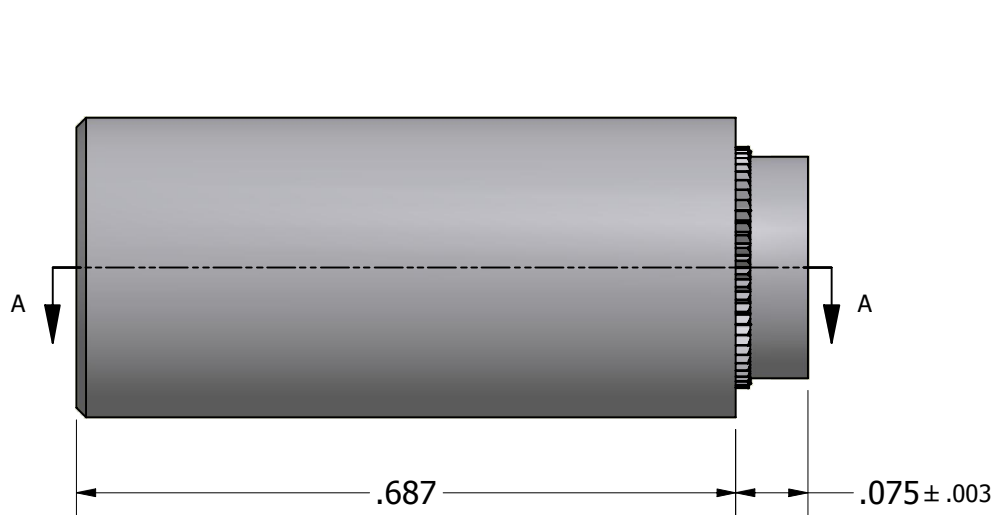

Tolerances Unless Otherwise Specified:

.xx Decimal: ± .02
 .xxx Decimal: ± .005
 Fraction: ± 1/64
 Angle: ± 2°

LYN-TRON, INC.

Part Number:

ST6918SPA-0.687

Description:

5/16" Rnd 10-32 Swage Standoff

Drawn By:

COURTNEYS06/27/2012

Gauge:

Material:

Steel

Scale:

5 : 1