

SECTION A-A

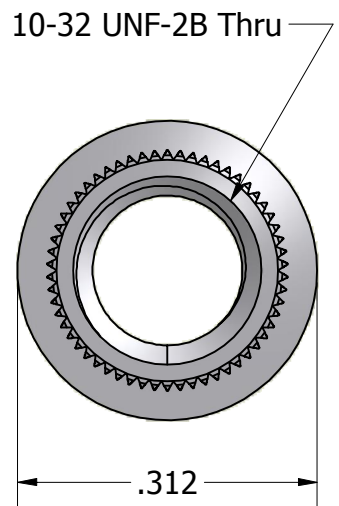

ISO SCALE 2 : 1

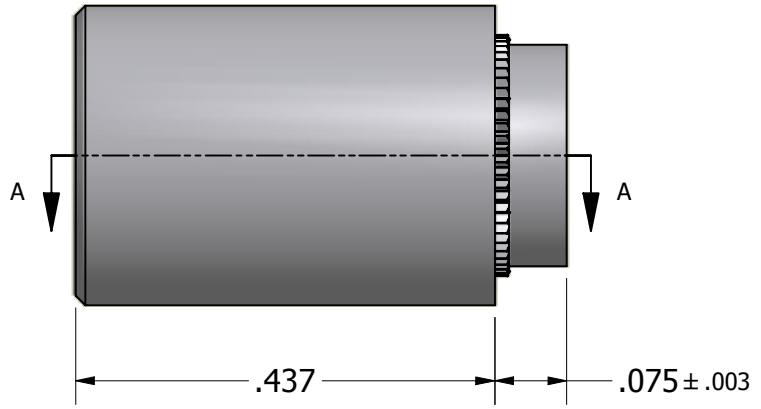

Tolerances Unless Otherwise Specified:
 .xx Decimal: ± .02
 .xxx Decimal: ± .005
 Fraction: ± 1/64
 Angle: ± 2°

LYN-TRON, INC.

Part Number:
ST6918SPA-0.437

Description:
5/16" Rnd 10-32 Swage Standoff

Drawn By:
COURTNEYS06/27/2012

Gauge:

Material:
Steel

Scale:
5 : 1