

SECTION A-A

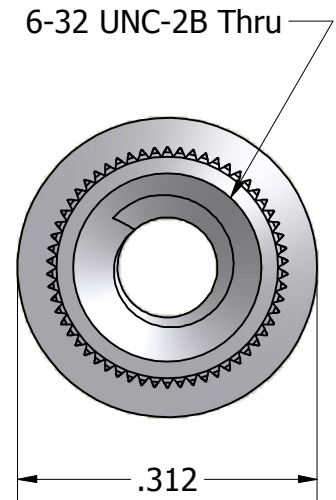

ISO SCALE 2 : 1

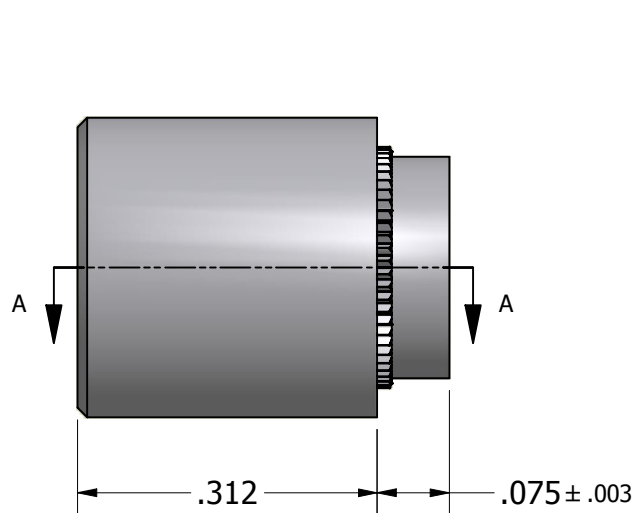

Tolerances Unless Otherwise Specified:

.xx Decimal: ± .02
.xxx Decimal: ± .005
Fraction: ± 1/64
Angle: ± 2°

LYN-TRON, INC.

Part Number:

ST6907SPA-0.312

Description:

5/16" Rnd 6-32 Swage Standoff

Drawn By:

COURTNEYS06/12/2012

Gauge:

Material:

Steel

Scale:

5 : 1