

SECTION A-A

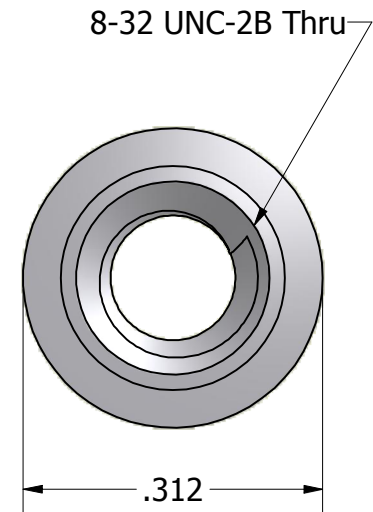

ISO SCALE 2 : 1

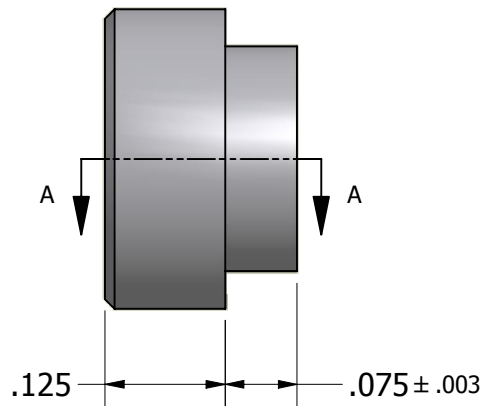

Tolerances Unless Otherwise Specified:

**.xx Decimal:** ± .02  
**.xxx Decimal:** ± .005  
**Fraction:** ± 1/64  
**Angle:** ± 2°

**LYN-TRON, INC.**

Part Number:

**ST6903A-0.125**

Description:

**5/16 Round Swage Standoff**

Drawn By:

**JEFFN**

**06/23/2010**

Gauge:

Material:

**Steel**

Scale:

**5 : 1**