

SECTION A-A

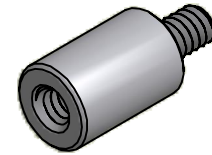

ISO SCALE 2 : 1

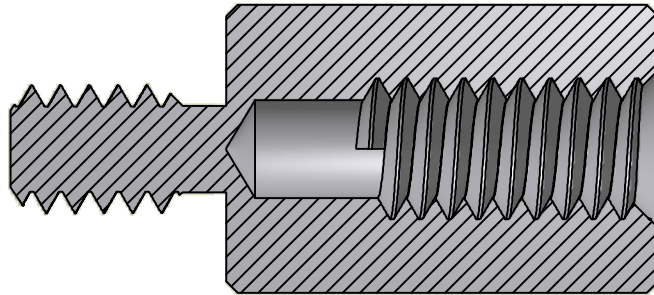
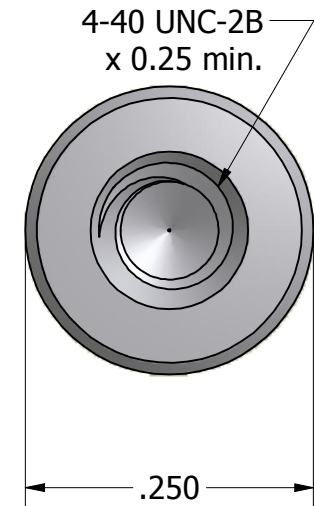
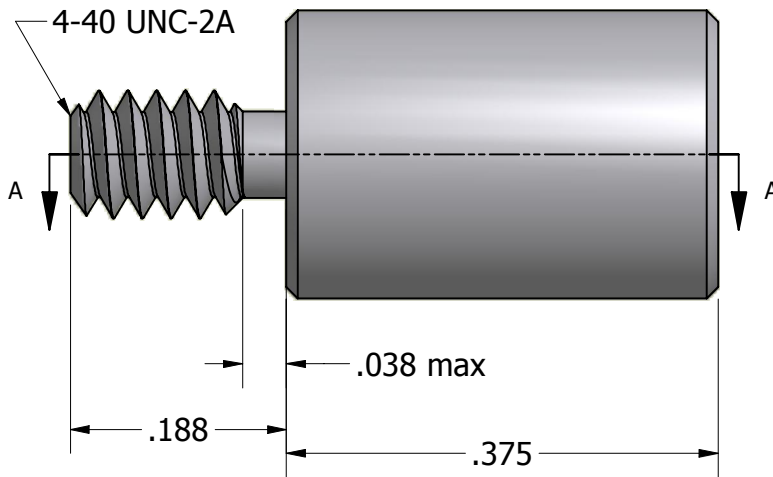

Tolerances Unless Otherwise Specified:

.xx Decimal: ± .02
.xxx Decimal: ± .005
Fraction: ± 1/64
Angle: ± 2°

LYN-TRON, INC.

Part Number:

ST6880-0.375

Description:

1/4 Round Male-Female Standoff

Drawn By:

COURTNEYS07/05/2011

Gauge:

Material:

Steel

Scale:

6 : 1