

ISO SCALE 3 : 1

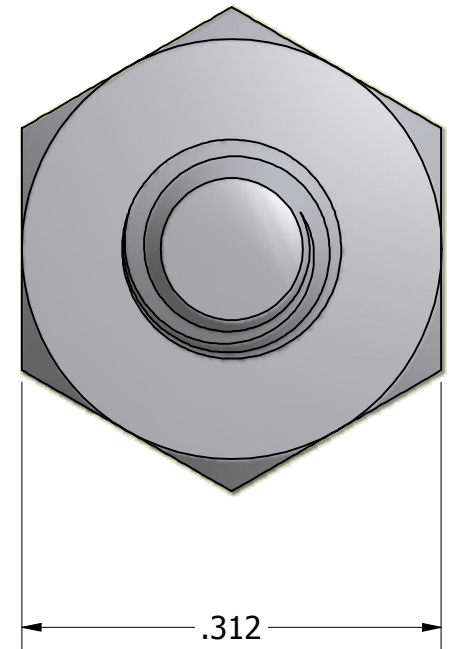
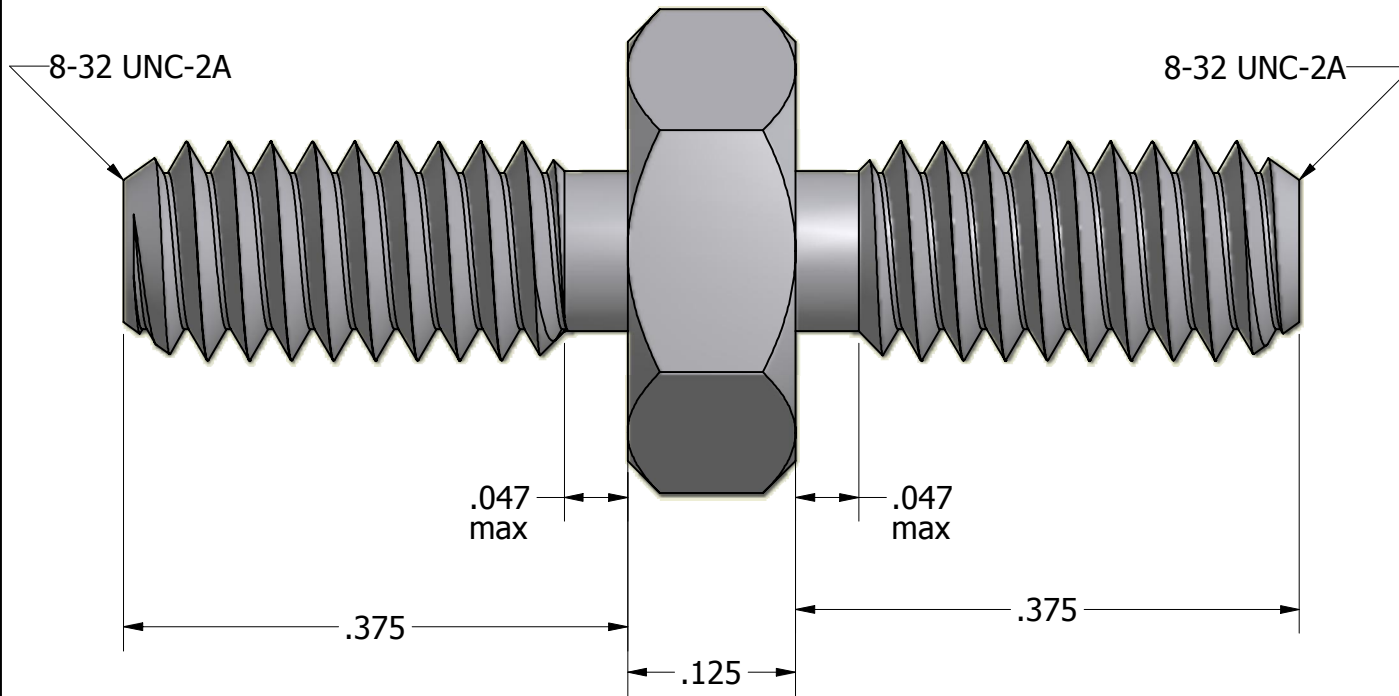

Tolerances Unless Otherwise Specified:

**.xx Decimal:** ± .02  
**.xxx Decimal:** ± .005  
**Fraction:** ± 1/64  
**Angle:** ± 2°

**LYN-TRON, INC.**

Part Number:

**ST6733**

Description:

**Male Male Standoff**

Drawn By:

**JEFFN**

**06/18/2010**

Gauge:

Material:

**Steel**

Scale:

**7 : 1**