

SECTION A-A

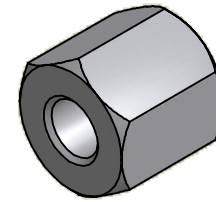

ISO SCALE 3 : 1

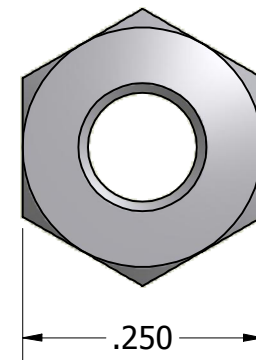
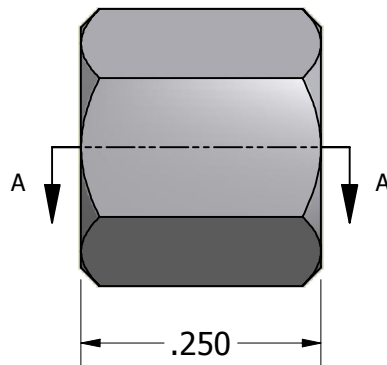

Tolerances Unless Otherwise Specified:

.xx Decimal: ± .02
.xxx Decimal: ± .005
Fraction: ± 1/64
Angle: ± 2°

LYN-TRON, INC.

Part Number:

ST6351-04-0.250

Description:

1/4 Hex Spacer

Drawn By:

COURTNEYS06/20/2010

Gauge:

Material:

Steel

Scale:

5 : 1