

SECTION A-A

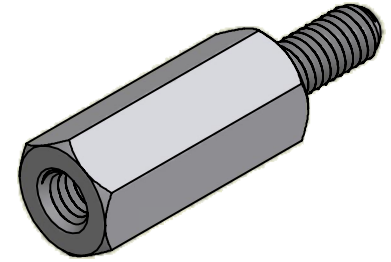

ISO SCALE 2 : 1

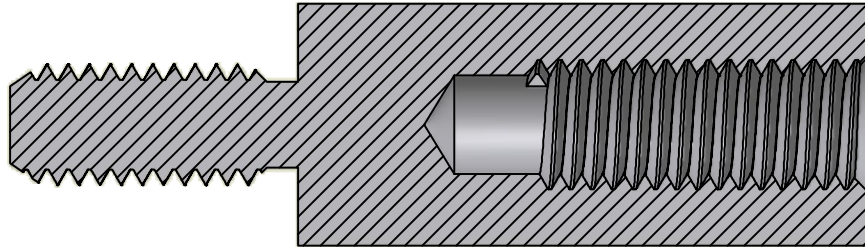
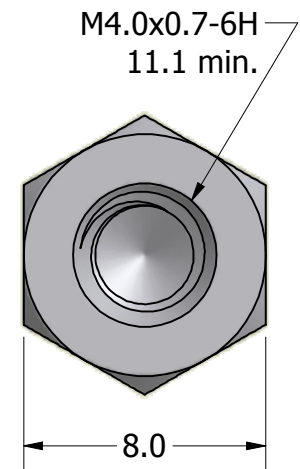
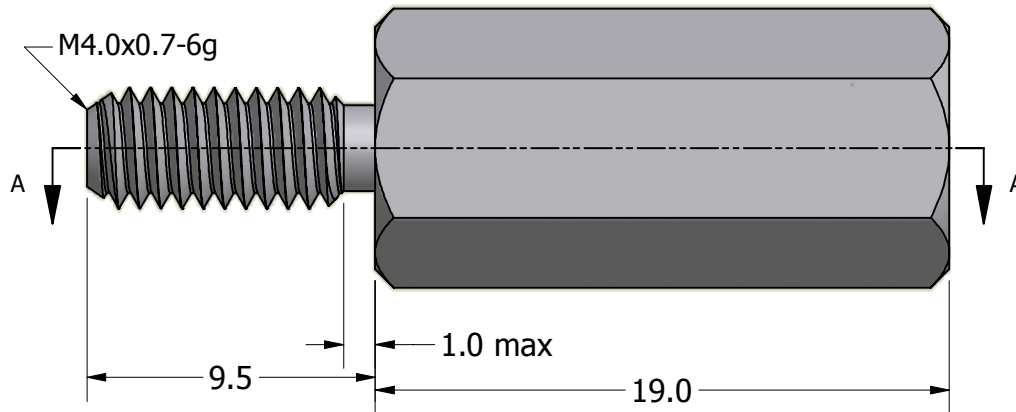

Tolerances Unless Otherwise Specified:

.x Decimal: ± 0.3
.xx Decimal: ± .13
Fraction: ± 1/64
Angle: ± 2°

LYN-TRON, INC.

Part Number:

ST5176-19.0

Description:

8mm Hex M4x.7 M/F Standoff

Drawn By:

COURTNEYS08/09/2012

Gauge:

Material:

Steel

Scale:

4 : 1