

SECTION A-A

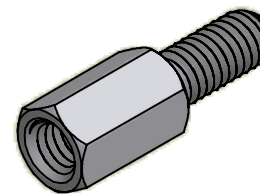

ISO SCALE 2 : 1

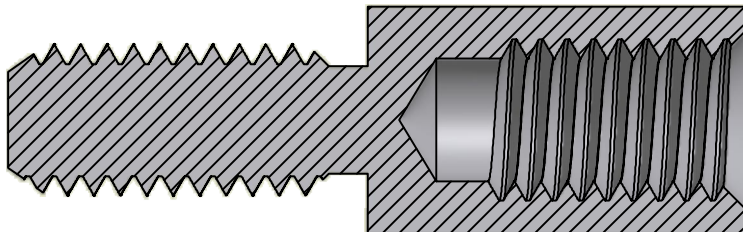
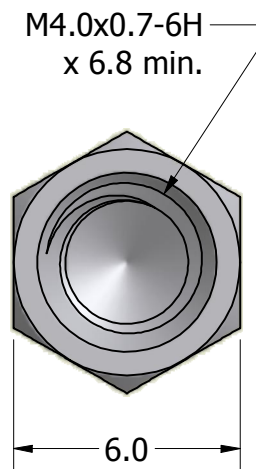
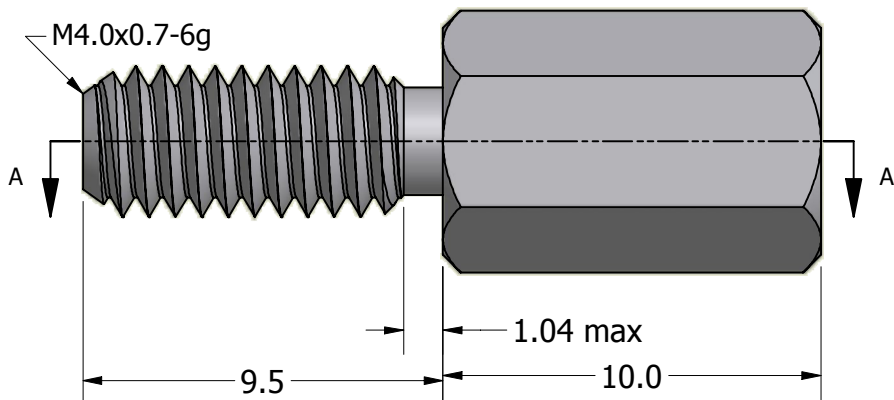

Tolerances Unless Otherwise Specified:

.x Decimal: ± 0.3
 .xx Decimal: $\pm .13$
 Fraction: $\pm 1/64$
 Angle: $\pm 2^\circ$

LYN-TRON, INC.

Part Number:
ST5174-10.0

Description:
6mm Hex M4x.7 M/F Standoff

Drawn By:
COURTNEYS08/28/2012

Gauge:
Steel

Material:
Steel

Scale:
5 : 1