

SECTION A-A

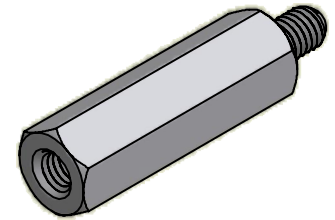

ISO SCALE 2 : 1

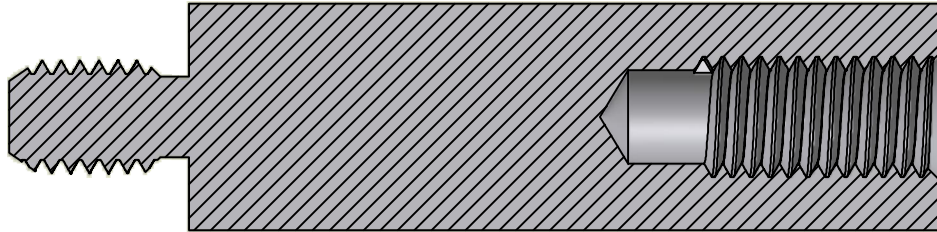
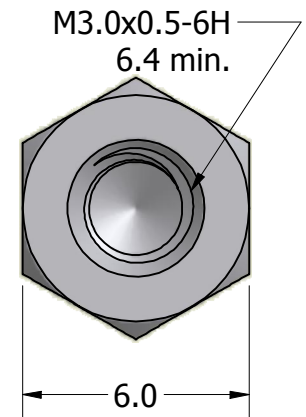
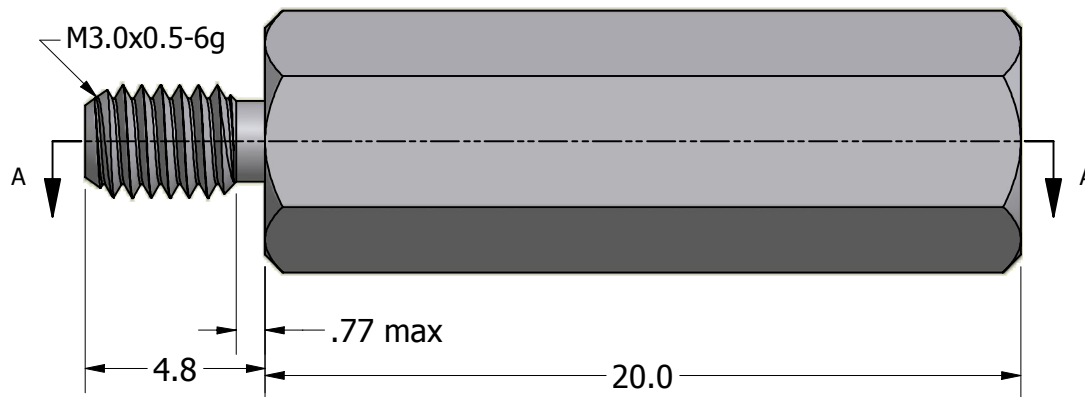

Tolerances Unless Otherwise Specified:

.x Decimal: ± 0.3
.xx Decimal: ± .13
Fraction: ± 1/64
Angle: ± 2°

LYN-TRON, INC.

Part Number:

ST5172-20.0

Description:

6mm Hex M3x.5 M/F Standoff

Drawn By:

COURTNEYS08/28/2012

Gauge:

Material:

Steel

Scale:

5 : 1