

SECTION A-A

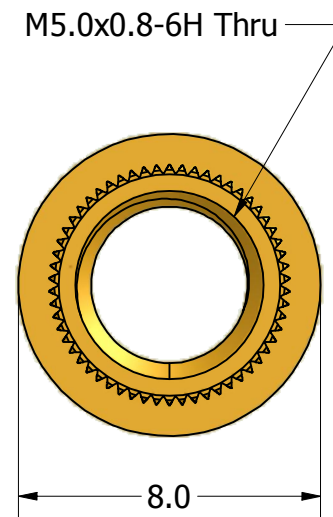

ISO SCALE 2 : 1

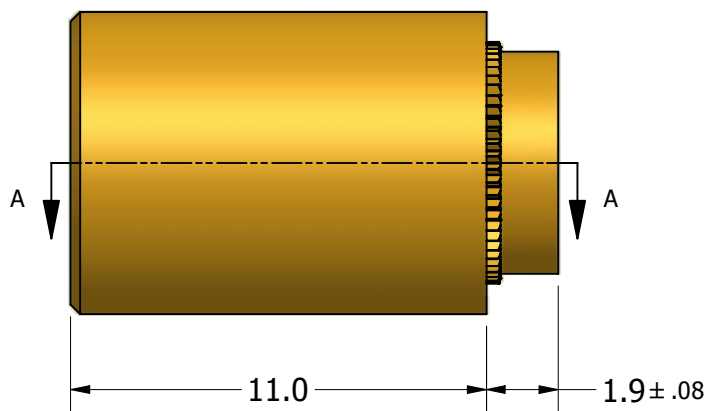

Tolerances Unless Otherwise Specified:

.x Decimal: ± 0.3  
 .xx Decimal: ± .13  
 Fraction: ± 1/64  
 Angle: ± 2°

**LYN-TRON, INC.**

Part Number:

**ST5119SPA-11.0**

Description:

**8mm Rnd M5X.8 Swage Standoff**

Drawn By:

**COURTNEYS08/03/2012**

Gauge:

Material:

**Steel**

Scale:

**5 : 1**