

SECTION A-A

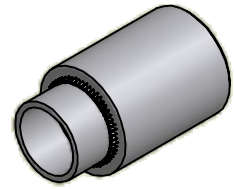

ISO SCALE 2 : 1

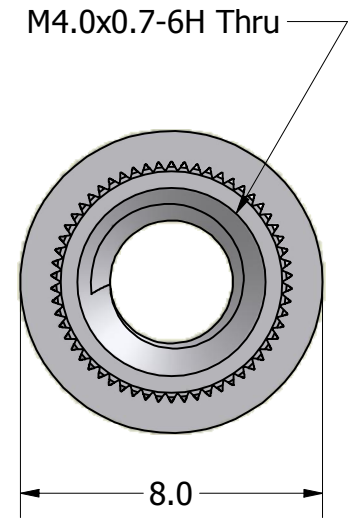
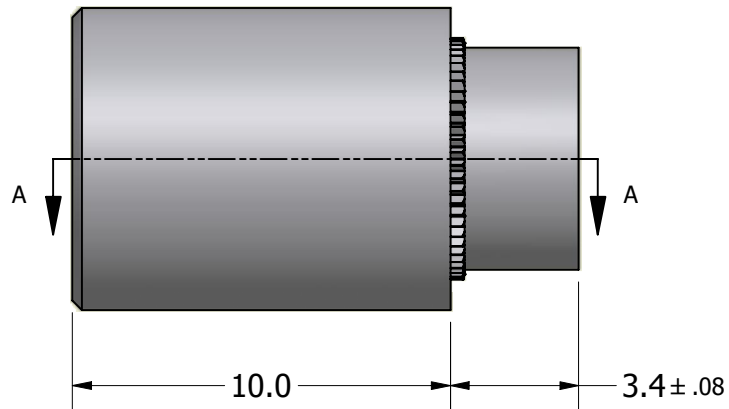

Tolerances Unless Otherwise Specified:  
 .x Decimal: ± 0.3  
 .xx Decimal: ± .13  
 Fraction: ± 1/64  
 Angle: ± 2°

**LYN-TRON, INC.**

Part Number:  
**ST5118SPC-10.0**

Description:  
**8mm Rnd M4X.7 Swage Standoff**

Drawn By:  
**COURTNEYS08/06/2012**

Gauge:

Material:  
**Steel**

Scale:  
**5 : 1**