

SECTION A-A

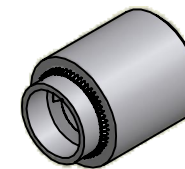

ISO SCALE 2 : 1

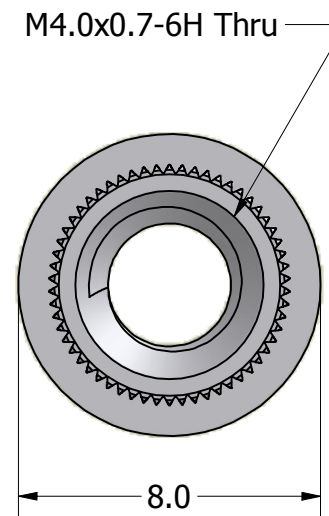
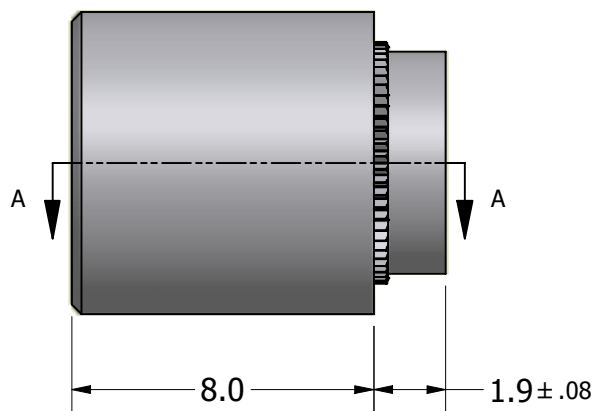

Tolerances Unless Otherwise Specified:

.x Decimal: ± 0.3
 .xx Decimal: ± .13
 Fraction: ± 1/64
 Angle: ± 2°

LYN-TRON, INC.

Part Number:

ST5118SPA-08.0

Description:

8mm Rnd M4X.7 Swage Standoff

Drawn By:

COURTNEYS08/06/2012

Gauge:

Material:

Steel

Scale:

5 : 1