

SECTION A-A

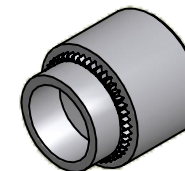

ISO SCALE 3 : 1

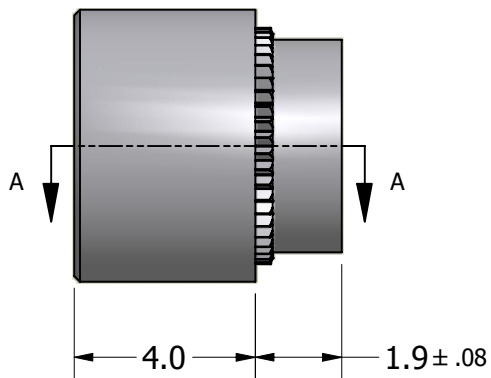

M3.0x0.5-6H Thru

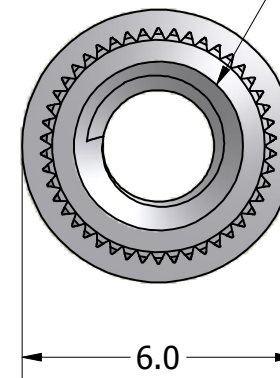

Tolerances Unless Otherwise Specified:

.x Decimal: ± 0.3
 .xx Decimal: ± .13
 Fraction: ± 1/64
 Angle: ± 2°

LYN-TRON, INC.

Part Number:

ST5114SPA-04.0

Description:

6mm Rnd M3X.5 Swage Standoff

Drawn By:

COURTNEYS07/05/2012

Gauge:

Material:

Steel

Scale:

6 : 1