

SECTION A-A

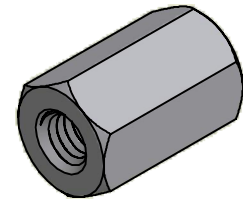

ISO SCALE 2 : 1

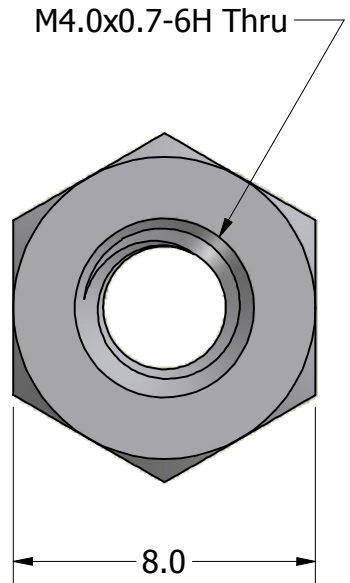
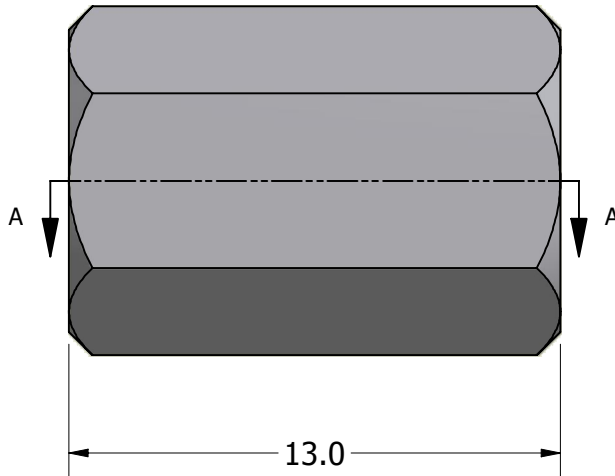

Tolerances Unless Otherwise Specified:

.x Decimal: ± 0.3
.xx Decimal: ± .13
Fraction: ± 1/64
Angle: ± 2°

LYN-TRON, INC.

Part Number:

ST5085-4070-13.0

Description:

8mm Hex Standoff

Drawn By:

COURTNEYS06/21/2010

Gauge:

Material:

Steel

Scale:

5 : 1