

SECTION A-A

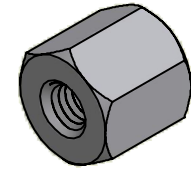

ISO SCALE 2 : 1

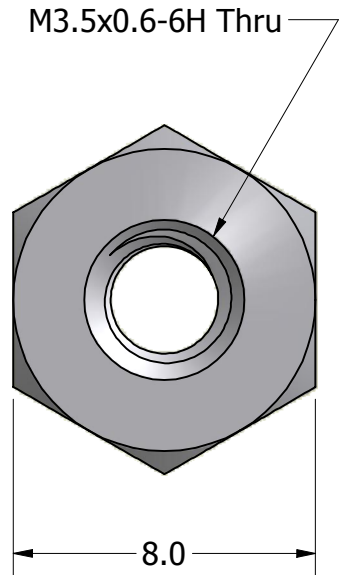
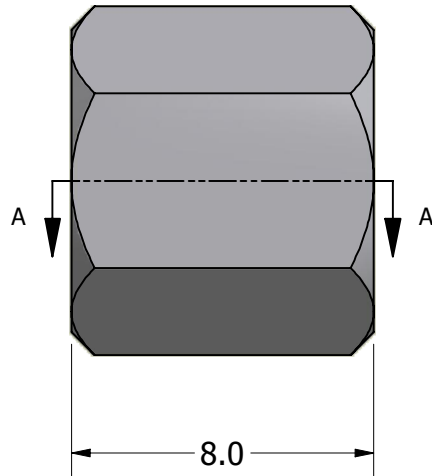

Tolerances Unless Otherwise Specified:

**.x Decimal:** ± 0.3  
**.xx Decimal:** ± .13  
**Fraction:** ± 1/64  
**Angle:** ± 2°

**LYN-TRON, INC.**

Part Number:

**ST5085-3560-08.0**

Description:

**8mm Hex Standoff**

Drawn By:

**COURTNEYS06/21/2010**

Gauge:

Material:

**Steel**

Scale:

**5 : 1**