

SECTION A-A

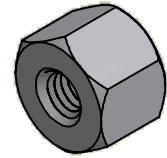

ISO SCALE 2 : 1

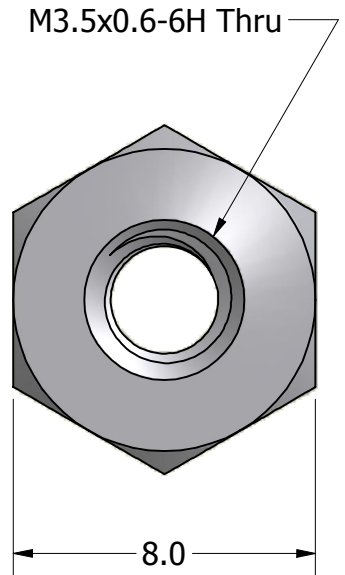
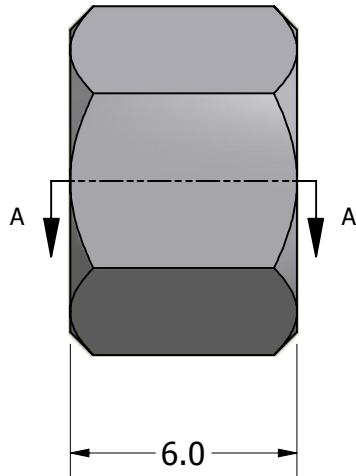

Tolerances Unless Otherwise Specified:

.x Decimal:  $\pm 0.3$   
 .xx Decimal:  $\pm .13$   
 Fraction:  $\pm 1/64$   
 Angle:  $\pm 2^\circ$

**LYN-TRON, INC.**

Part Number:

**ST5085-3560-06.0**

Description:

**8mm Hex Standoff**

Drawn By:

**COURTNEYS06/21/2010**

Gauge:

Material:

**Steel**

Scale:

**5 : 1**