

SECTION A-A

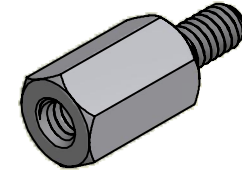

ISO SCALE 1 : 1

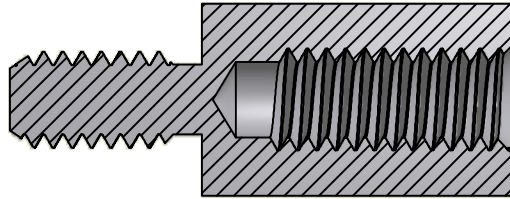
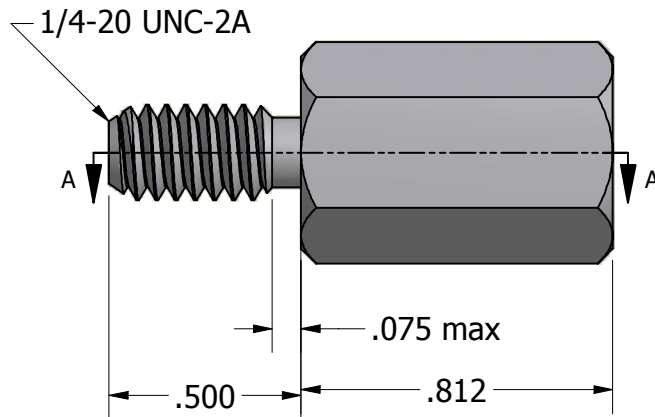

1/4-20 UNC-2B
x 0.625 min.

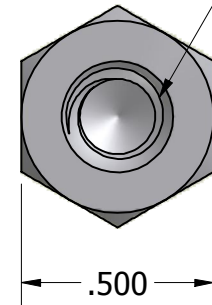

Tolerances Unless Otherwise Specified:

.xx Decimal: ± .02
.xxx Decimal: ± .005
Fraction: ± 1/64
Angle: ± 2°

LYN-TRON, INC.

Part Number:

SS6988-0.812

Description:

1/2 Hex Male-Female Standoff

Drawn By:

RICKZ 02/28/2012

Gauge:

Material:

Stainless Steel

Scale:

2 : 1