

SECTION A-A

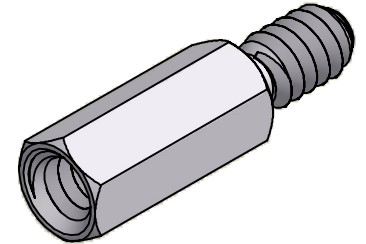

ISO SCALE 3 : 1

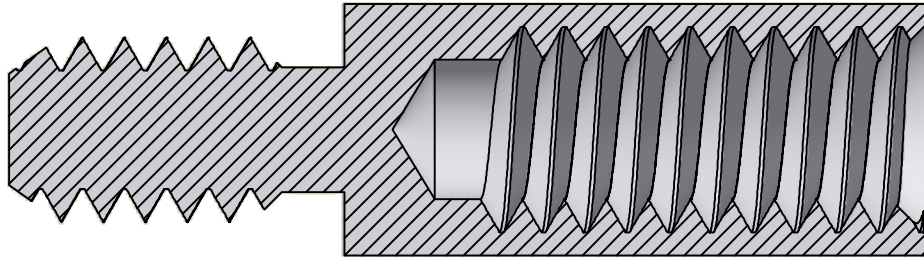
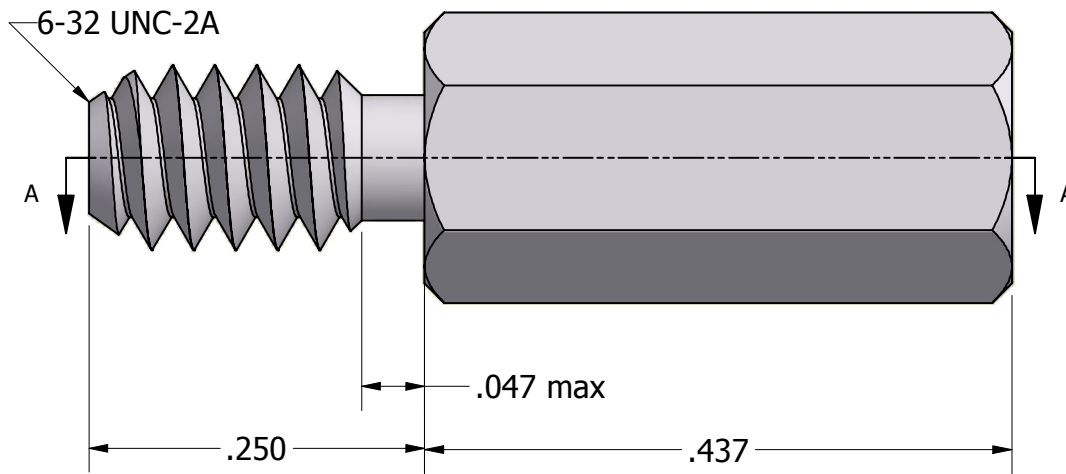

6-32 UNC-2B
x 0.323 min.

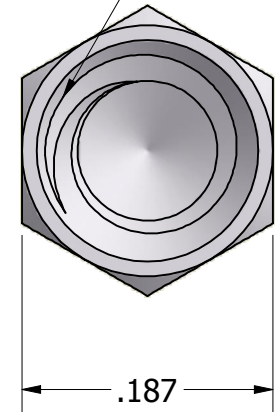

Tolerances Unless Otherwise Specified:

.xx Decimal: ± .02
.xxx Decimal: ± .005
Fraction: ± 1/64
Angle: ± 2°

LYN-TRON, INC.

Part Number:

SS6977-0.437

Description:

3/16 Hex Male-Female Standoff

Drawn By:

KENANG 07/05/2011

Gauge:

Material:

Stainless Steel

Scale:

7 : 1