

SECTION A-A

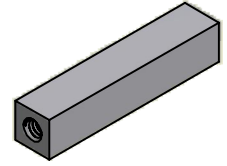

ISO SCALE 1 : 1

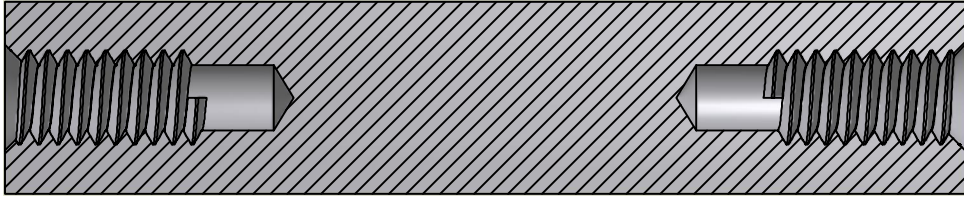
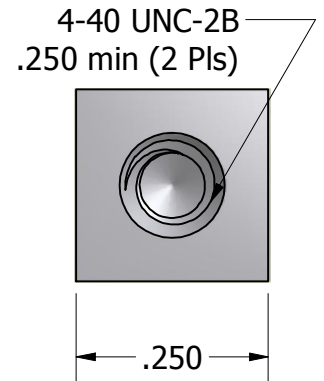
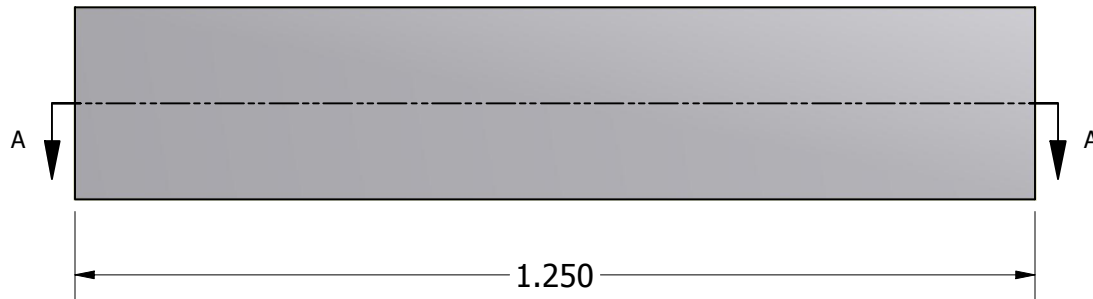

Tolerances Unless Otherwise Specified:

.xx Decimal: ± .02
.xxx Decimal: ± .005
Fraction: ± 1/64
Angle: ± 2°

LYN-TRON, INC.

Part Number:
SS6961-0440-1.250

Description:
1/4 Square Standoff

Drawn By:
RICKZ 09/08/2011

Gauge:

Material:
Stainless Steel

Scale:
4 : 1