

SECTION A-A

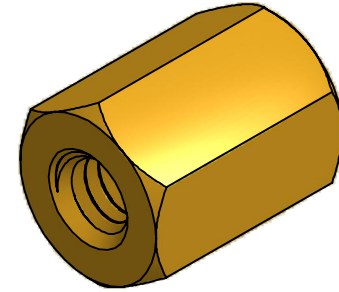

ISO SCALE 2 : 1

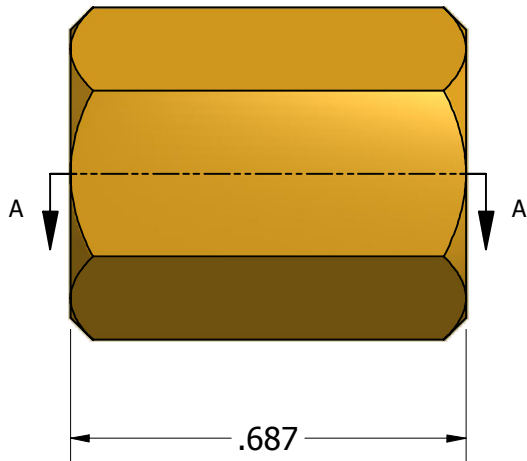

1/4-20 UNC-2B Thru

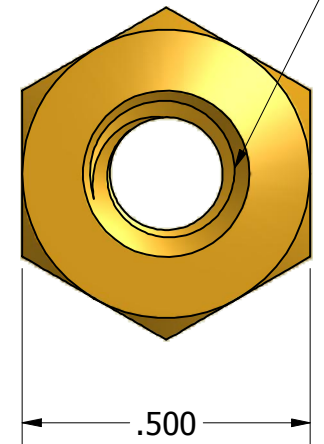

Tolerances Unless Otherwise Specified:

.xx Decimal: ± .02
.xxx Decimal: ± .005
Fraction: ± 1/64
Angle: ± 2°

LYN-TRON, INC.

Part Number:
SS6955-2520-0.687

Description:
1/2 Hex Standoff

Drawn By:
JEFFN 07/10/2010

Gauge:

Material:
Stainless Steel

Scale:
3 : 1