

SECTION A-A

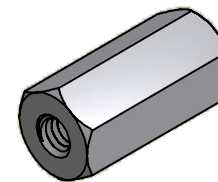

ISO SCALE 1 : 1

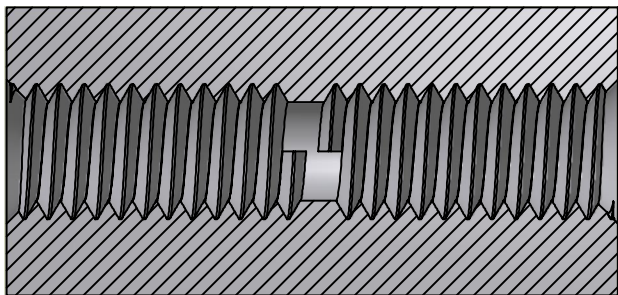
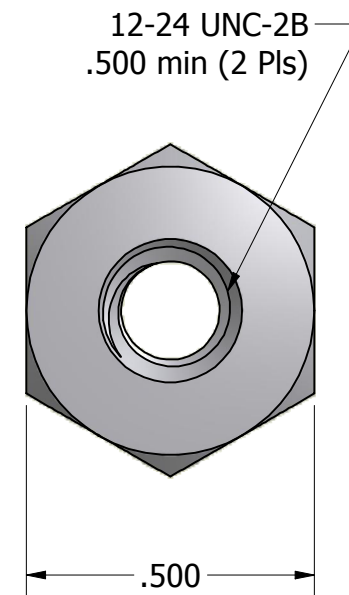
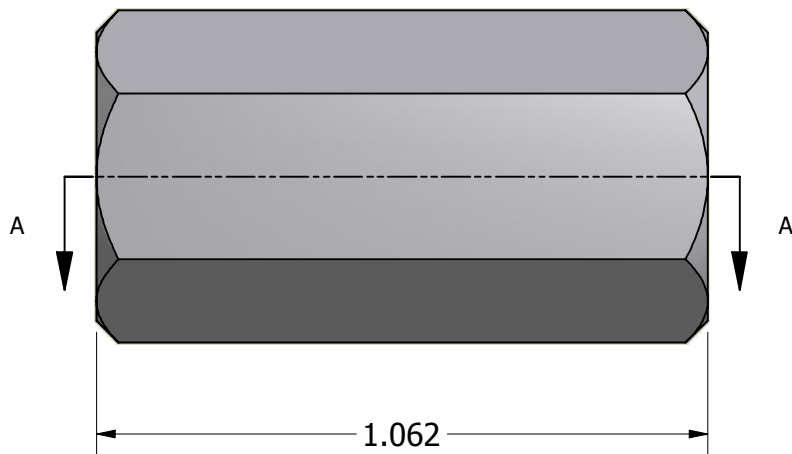

Tolerances Unless Otherwise Specified:

**.xx Decimal:** ± .02  
**.xxx Decimal:** ± .005  
**Fraction:** ± 1/64  
**Angle:** ± 2°

**LYN-TRON, INC.**

Part Number:  
**SS6955-1224-1.062**

Description:  
**1/2 Hex Standoff**

Drawn By:  
**JEFFN 07/10/2010**

Gauge:

Material:  
**Stainless Steel**

Scale:  
**3 : 1**