

SECTION A-A

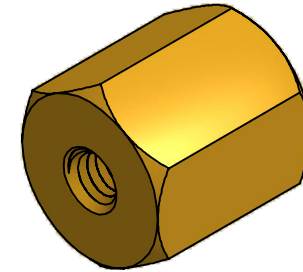

ISO SCALE 2 : 1

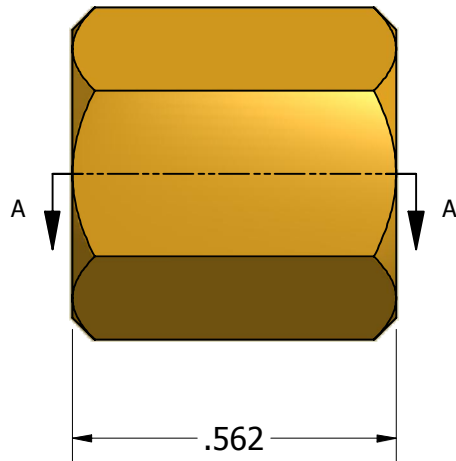

8-32 UNC-2B Thru

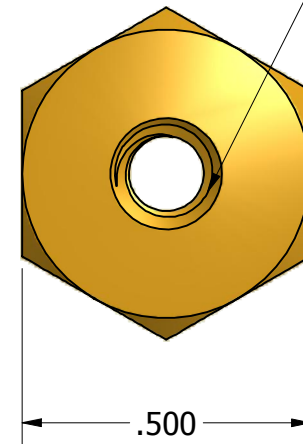

Tolerances Unless Otherwise Specified:

.xx Decimal: ± .02
.xxx Decimal: ± .005
Fraction: ± 1/64
Angle: ± 2°

LYN-TRON, INC.

Part Number:

SS6955-0832-0.562

Description:

1/2 Hex Standoff

Drawn By:

JEFFN

07/10/2010

Gauge:

Material:

Stainless Steel

Scale:

3 : 1