

SECTION A-A

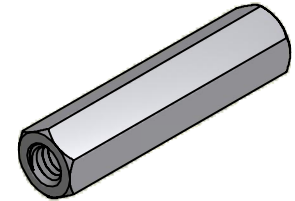

ISO SCALE 1 : 1

12-24 UNC-2B  
.500 min (2 Pls)

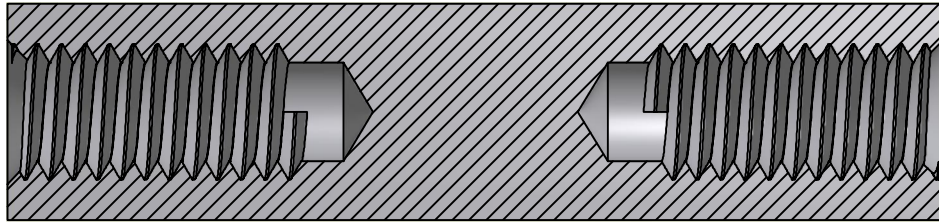
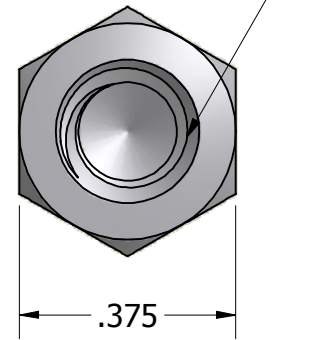
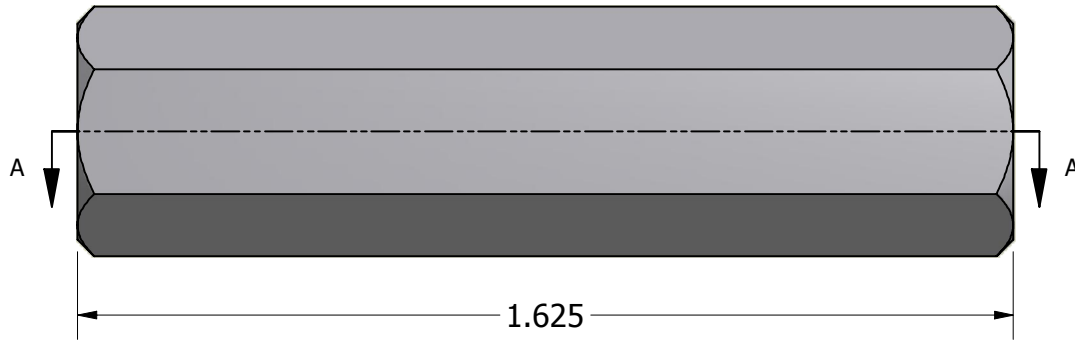

Tolerances Unless Otherwise Specified:

**.xx Decimal:** ± .02  
**.xxx Decimal:** ± .005  
**Fraction:** ± 1/64  
**Angle:** ± 2°

**LYN-TRON, INC.**

Part Number:

**SS6953-1224-1.625**

Description:

**3/8 Hex Standoff**

Drawn By:

**JEFFN**

**07/12/2010**

Gauge:

Material:

**Stainless Steel**

Scale:

**3 : 1**