

SECTION A-A

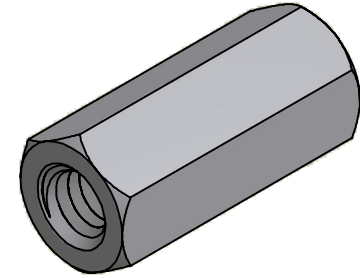

ISO SCALE 2 : 1

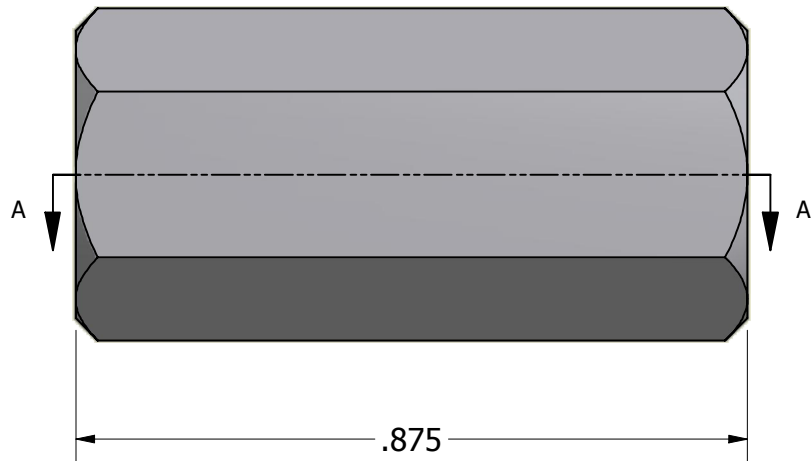

12-24 UNC-2B Thru

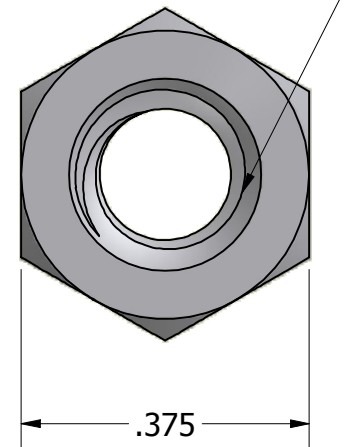

Tolerances Unless Otherwise Specified:

**.xx Decimal:** ± .02  
**.xxx Decimal:** ± .005  
**Fraction:** ± 1/64  
**Angle:** ± 2°

**LYN-TRON, INC.**

Part Number:

**SS6953-1224-0.875**

Description:

**3/8 Hex Standoff**

Drawn By:

**JEFFN**

**07/12/2010**

Gauge:

Material:

**Stainless Steel**

Scale:

**4 : 1**