

SECTION A-A

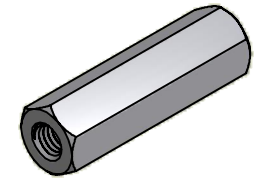

ISO SCALE 1 : 1

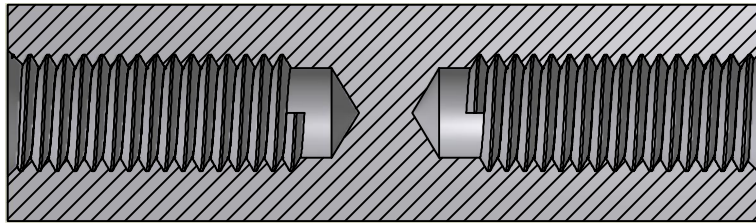
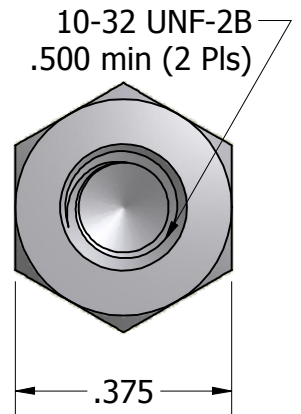
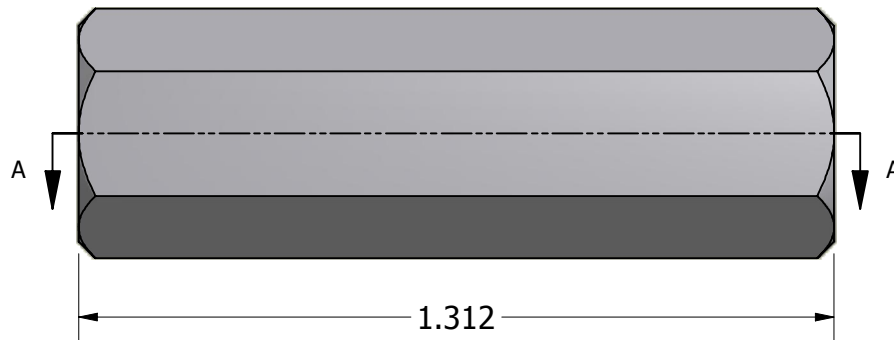

Tolerances Unless Otherwise Specified:

.xx Decimal: ± .02
.xxx Decimal: ± .005
Fraction: ± 1/64
Angle: ± 2°

LYN-TRON, INC.

Part Number:

SS6953-1032-1.312

Description:

3/8 Hex Standoff

Drawn By:

JEFFN

07/12/2010

Gauge:

Material:

Stainless Steel

Scale:

3 : 1