

SECTION A-A

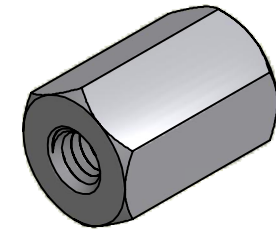

ISO SCALE 2 : 1

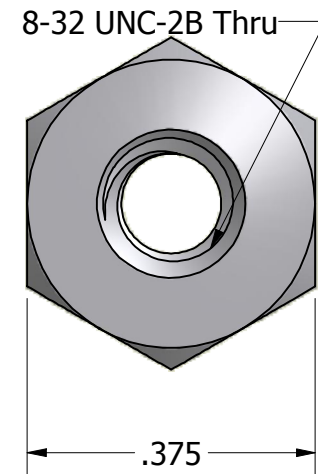
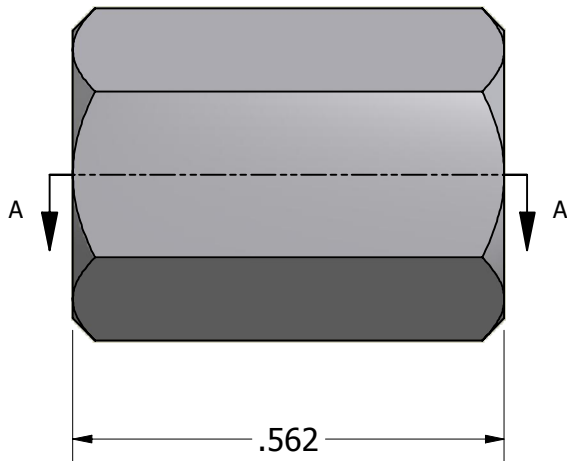

Tolerances Unless Otherwise Specified:			
.xx Decimal:	± .02		
.xxx Decimal:	± .005	Part Number:	
Fraction:	± 1/64	<b>SS6953-0832-0.562</b>	
Angle:	± 2°	Description:	
		<b>3/8 Hex Standoff</b>	
Drawn By:	Gauge:	Material:	Scale:
<b>JEFFN</b>	<b>07/12/2010</b>	<b>Stainless Steel</b>	<b>4 : 1</b>