

SECTION A-A

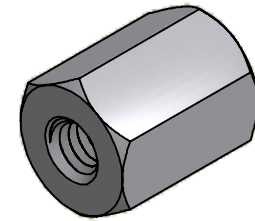

ISO SCALE 2 : 1

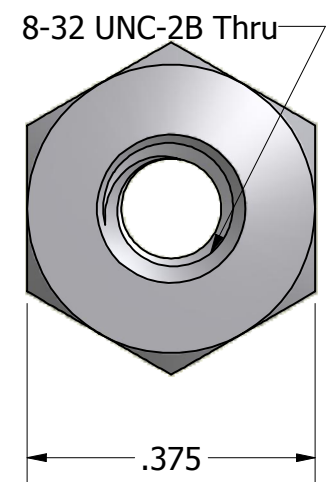
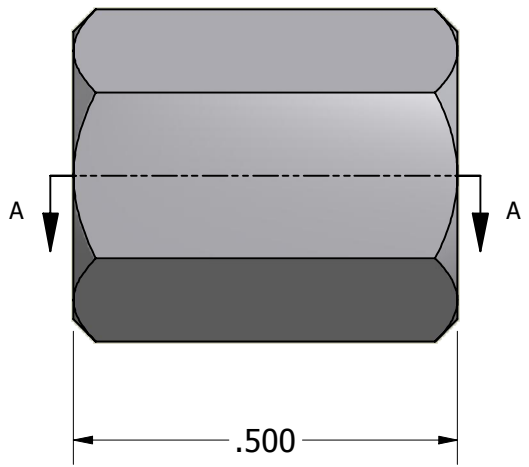

Tolerances Unless Otherwise Specified:			
.xx Decimal:	± .02		
.xxx Decimal:	± .005	Part Number:	
Fraction:	± 1/64	SS6953-0832-0.500	
Angle:	± 2°	Description:	
		3/8 Hex Standoff	
Drawn By:	Gauge:	Material:	Scale:
JEFFN	07/12/2010	Stainless Steel	4 : 1