

SECTION A-A

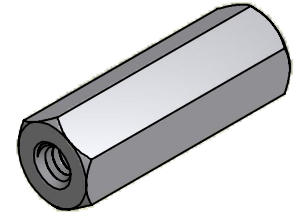

ISO SCALE 2 : 1

4-40 UNC-2B
.250 min (2 Pls)

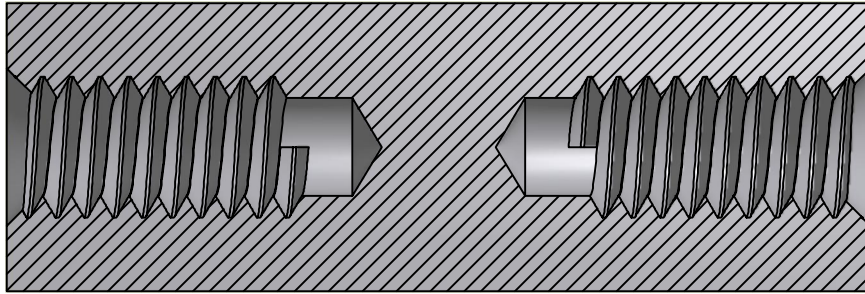
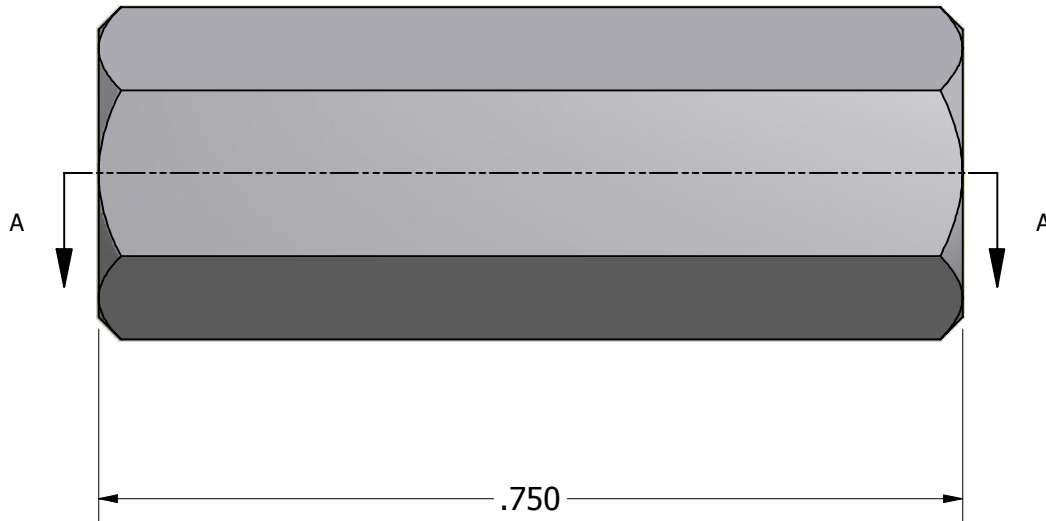
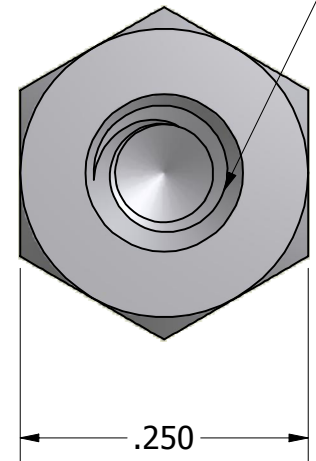

Tolerances Unless Otherwise Specified:

.xx Decimal: ± .02
.xxx Decimal: ± .005
Fraction: ± 1/64
Angle: ± 2°

LYN-TRON, INC.

Part Number:

SS6951-0440-0.750

Description:

1/4 Hex Standoff

Drawn By:

JEFFN

07/09/2010

Gauge:

Material:

Stainless Steel

Scale:

6 : 1