

SECTION A-A

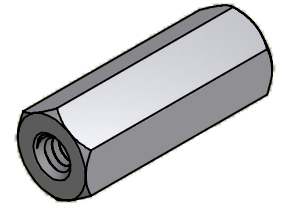

ISO SCALE 2 : 1

4-40 UNC-2B
.250 min (2 Pls)

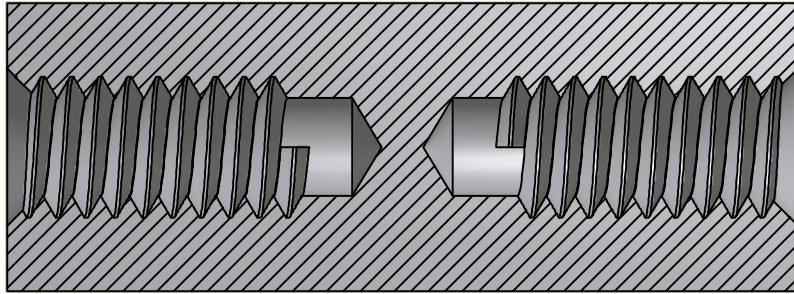
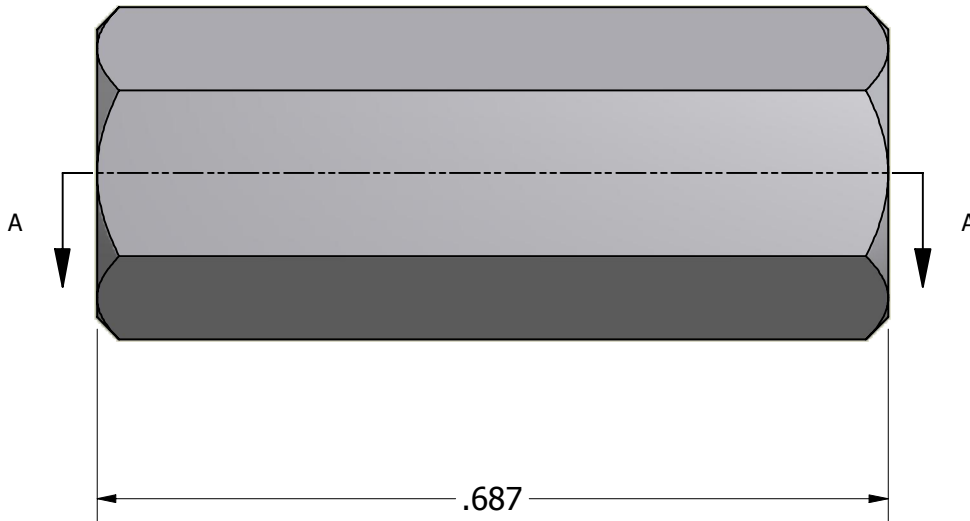
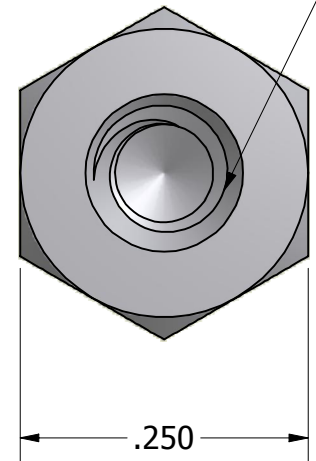

Tolerances Unless Otherwise Specified:

.xx Decimal: ± .02
.xxx Decimal: ± .005
Fraction: ± 1/64
Angle: ± 2°

LYN-TRON, INC.

Part Number:
SS6951-0440-0.687

Description:
1/4 Hex Standoff

Drawn By:
JEFFN 07/09/2010

Gauge:

Material:
Stainless Steel

Scale:
6 : 1