

SECTION A-A

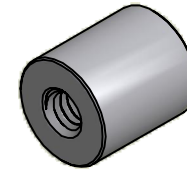

ISO SCALE 1 : 1

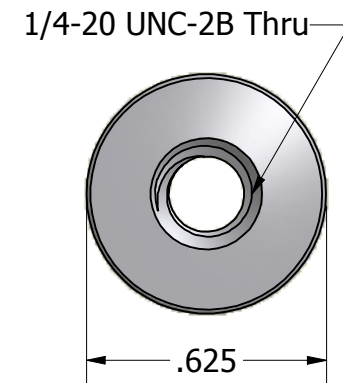
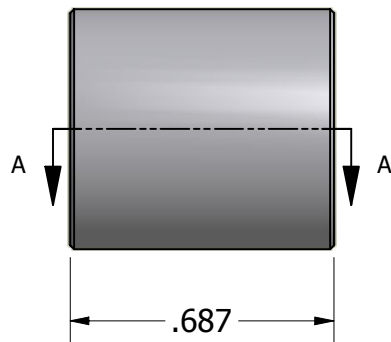

Tolerances Unless Otherwise Specified:			
.xx Decimal:	± .02		
.xxx Decimal:	± .005	Part Number:	
Fraction:	± 1/64	SS6946-2520-0.687	
Angle:	± 2°	Description:	
		5/8 Round Standoff	
Drawn By:	Gauge:	Material:	Scale:
JEFFN	07/09/2010	Stainless Steel	2 : 1