

SECTION A-A

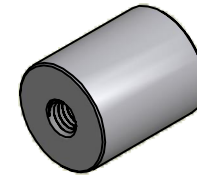

ISO SCALE 1 : 1

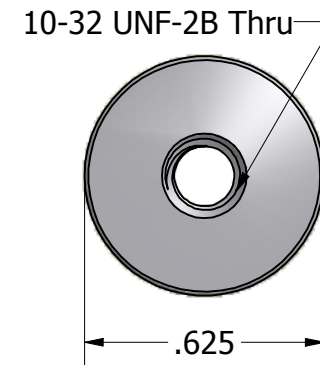
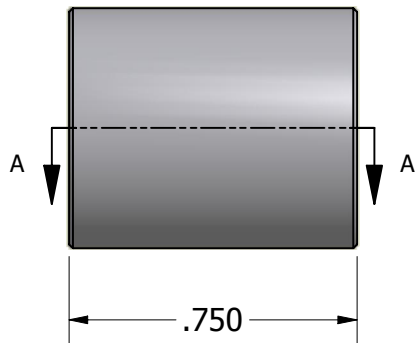

Tolerances Unless Otherwise Specified:			
.xx Decimal:	± .02		
.xxx Decimal:	± .005	Part Number:	
Fraction:	± 1/64	<b>SS6946-1032-0.750</b>	
Angle:	± 2°	Description:	
		<b>5/8 Round Standoff</b>	
Drawn By:	Gauge:	Material:	Scale:
<b>JEFFN</b>	<b>07/09/2010</b>	<b>Stainless Steel</b>	<b>2 : 1</b>