

SECTION A-A

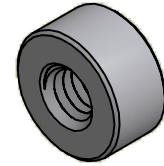

ISO SCALE 2 : 1

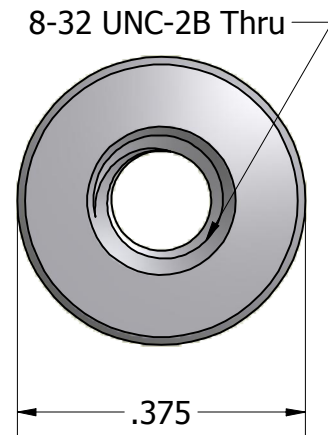
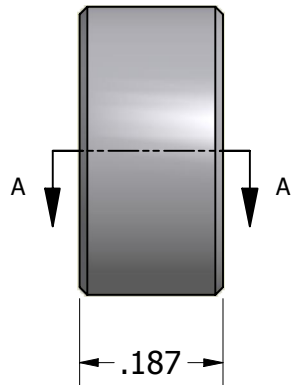

Tolerances Unless Otherwise Specified:

**.xx Decimal:** ± .02  
**.xxx Decimal:** ± .005  
**Fraction:** ± 1/64  
**Angle:** ± 2°

**LYN-TRON, INC.**

Part Number:  
**SS6943-0832-0.187**

Description:  
**3/8 Round Standoff**

Drawn By:  
**JEFFN 07/09/2010**

Gauge:

Material:  
**Stainless Steel**

Scale:  
**4 : 1**