

SECTION A-A

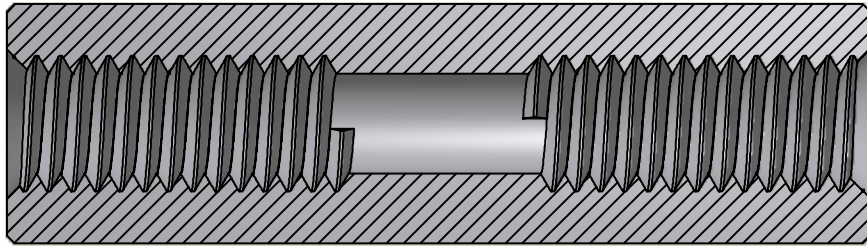

ISO SCALE 1 : 1

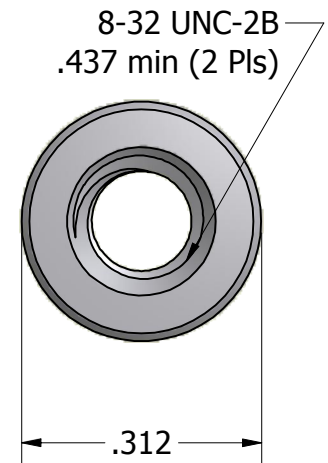
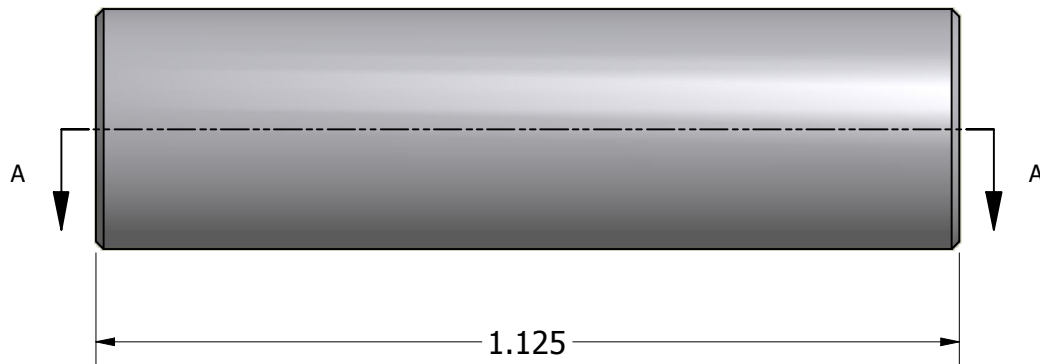

Tolerances Unless Otherwise Specified:

.xx Decimal: ± .02
.xxx Decimal: ± .005
Fraction: ± 1/64
Angle: ± 2°

LYN-TRON, INC.

Part Number:

SS6942-0832-1.125

Description:

5/16 Round Standoff

Drawn By:

COURTNEYS08/23/2011

Gauge:

Material:

Stainless Steel

Scale:

4 : 1