

SECTION A-A

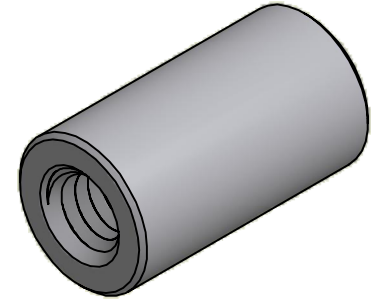

ISO SCALE 3 : 1

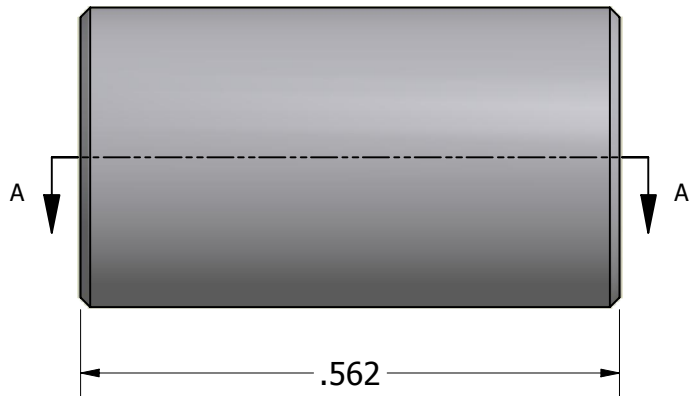

8-32 UNC-2B Thru

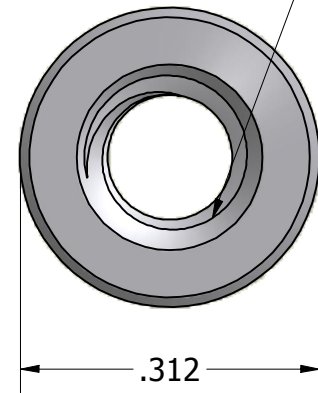

Tolerances Unless Otherwise Specified:

.xx Decimal: $\pm .02$
.xxx Decimal: $\pm .005$
Fraction: $\pm 1/64$
Angle: $\pm 2^\circ$

LYN-TRON, INC.

Part Number:

SS6942-0832-0.562

Description:

5/16 Round Standoff

Drawn By:

JEFFN

07/09/2010

Gauge:

Material:

Stainless Steel

Scale:

5 : 1