

SECTION A-A

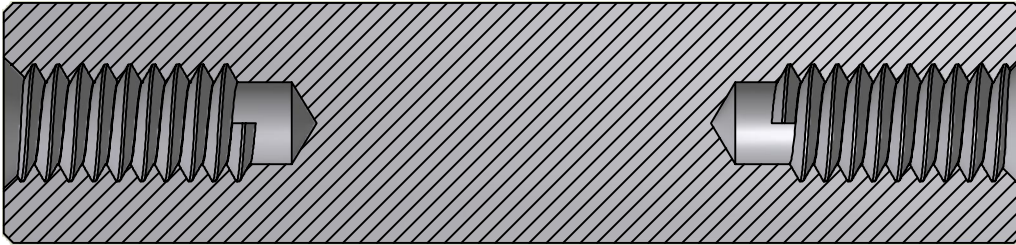

ISO SCALE 2 : 1

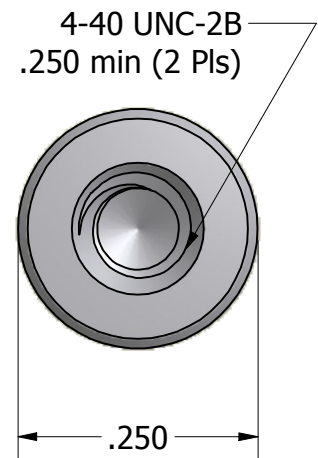
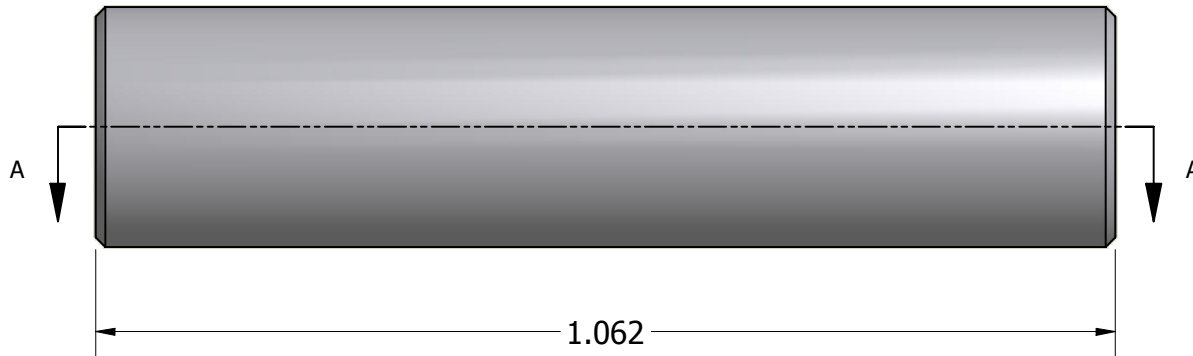

Tolerances Unless Otherwise Specified:

.xx Decimal: ± .02
.xxx Decimal: ± .005
Fraction: ± 1/64
Angle: ± 2°

LYN-TRON, INC.

Part Number:
SS6941-0440-1.062

Description:
1/4 Round Standoff

Drawn By:
JEFFN 07/08/2010

Gauge:

Material:
Stainless Steel

Scale:
5 : 1