

SECTION A-A

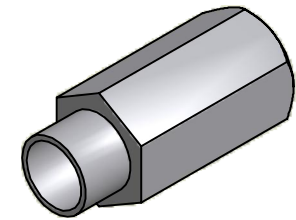

ISO SCALE 2 : 1

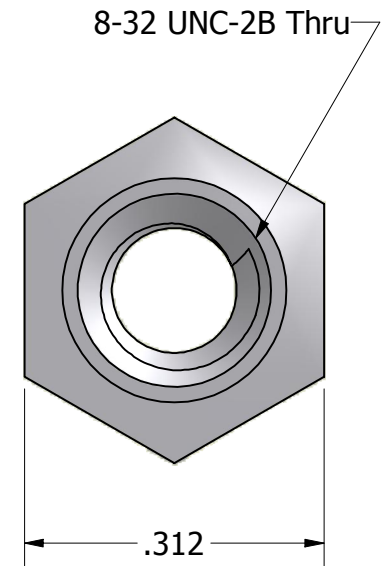
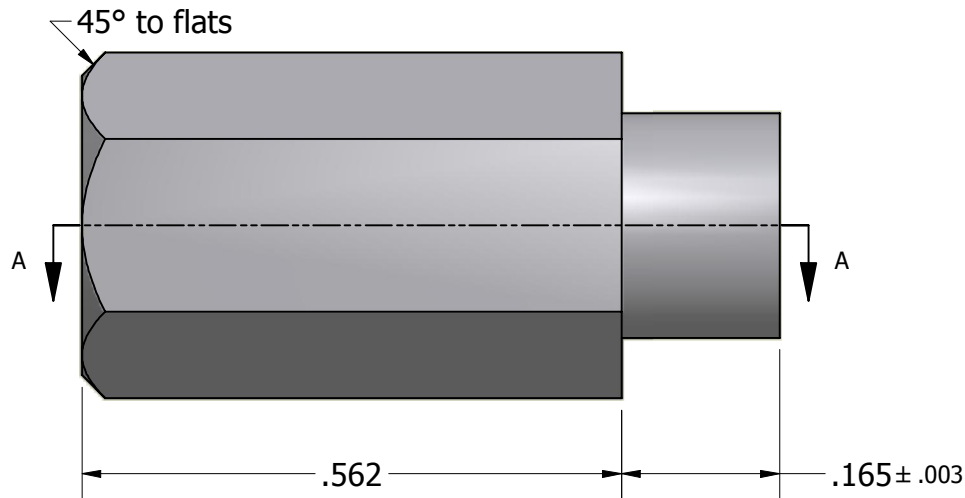

Tolerances Unless Otherwise Specified:

.xx Decimal: ± .02
 .xxx Decimal: ± .005
 Fraction: ± 1/64
 Angle: ± 2°

LYN-TRON, INC.

Part Number:
SS6923D-0.562

Description:
5/16 Hex Swage Standoff

Drawn By:
JEFFN 06/22/2010

Gauge:

Material:
Stainless Steel

Scale:
5 : 1