

SECTION A-A

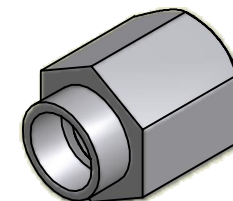

ISO SCALE 3 : 1

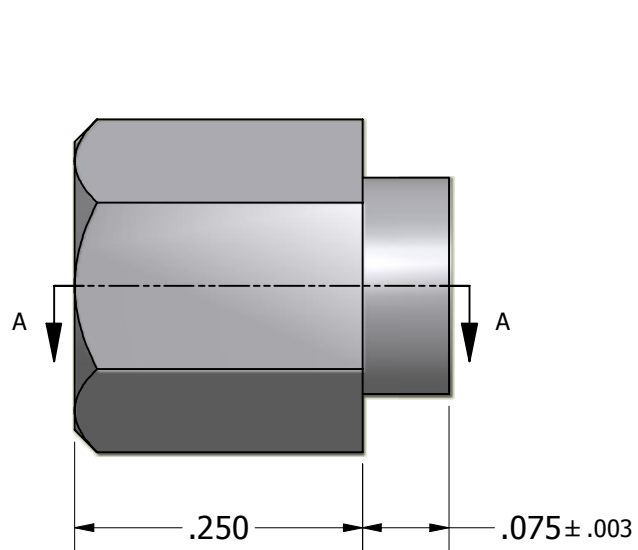

6-32 UNC-2B Thru

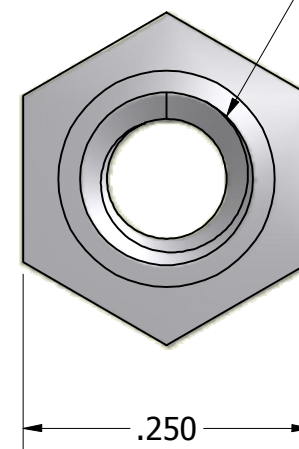

Tolerances Unless Otherwise Specified:

.xx Decimal: ± .02
.xxx Decimal: ± .005
Fraction: ± 1/64
Angle: ± 2°

LYN-TRON, INC.

Part Number:

SS6920A-0.250

Description:

1/4 Hex Swage Standoff

Drawn By:

JEFFN

06/22/2010

Gauge:

Material:

Stainless Steel

Scale:

6 : 1