

SECTION A-A

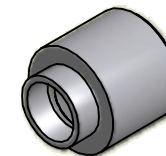

ISO SCALE 2 : 1

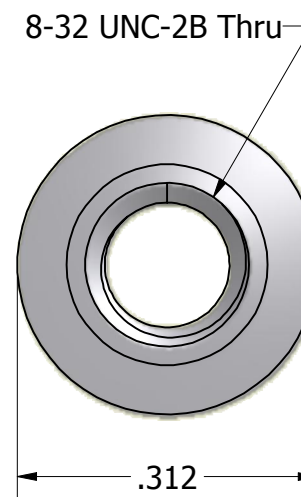
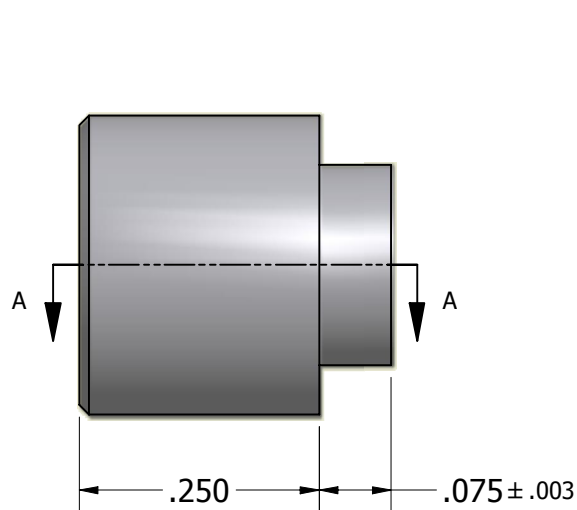

Tolerances Unless Otherwise Specified:

.xx Decimal: $\pm .02$
.xxx Decimal: $\pm .005$
Fraction: $\pm 1/64$
Angle: $\pm 2^\circ$

LYN-TRON, INC.

Part Number:

SS6919A-0.250

Description:

5/16 Round Swage Standoff

Drawn By:

JEFFN

06/22/2010

Gauge:

Material:

Stainless Steel

Scale:

5 : 1