

SECTION A-A

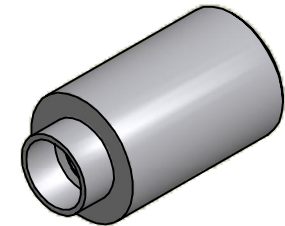

ISO SCALE 2 : 1

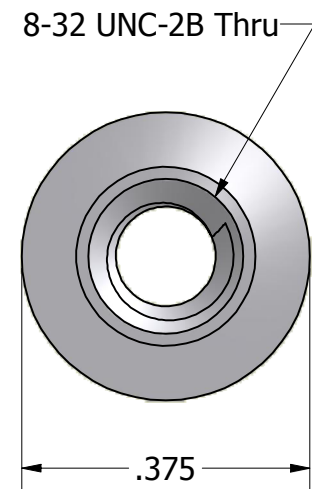
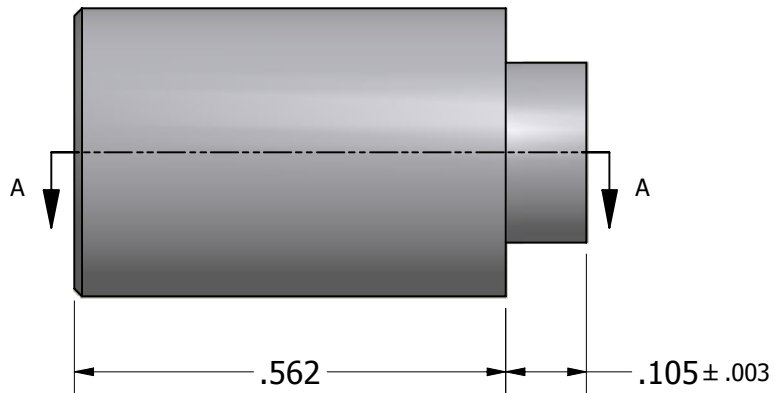

Tolerances Unless Otherwise Specified:

.xx Decimal: ± .02  
 .xxx Decimal: ± .005  
 Fraction: ± 1/64  
 Angle: ± 2°

**LYN-TRON, INC.**

Part Number:

**SS6914B-0.562**

Description:

**3/8 Round Swage Standoff**

Drawn By:

**COURTNEYS06/27/2010**

Gauge:

Material:

**Stainless Steel**

Scale:

**4 : 1**